



TEST REPORT

Reference No...... : WTX24X01018378W001
Manufacturer..... : Guangdong V Technology Co. LTD
Address..... : 3-4/F, Hongshi Industrial Park, No.120 Zhenxing Road, Dinghu District,
Zhaoqing City, Guangdong Province, China
Product Name..... : CCTV Camera
Model No...... : C6S2X-H
Standards..... : **ETSI EN 300 328 V2.2.2 (2019-07)**
Date of Receipt sample... : 2024-01-23
Date of Test..... : 2024-01-23 to 2024-02-23; 2024-02-28 to 2024-04-12
Date of Issue..... : 2024-04-12
Test Report Form No...... : WTX_ ETSI EN 300 328_2019W
Test Result..... : **Pass**

Remarks:

The results shown in this test report refer only to the sample(s) tested, this test report cannot be reproduced, except in full, without prior written permission of the company. The report would be invalid without specific stamp of test institute and the signatures of approver.

Prepared By:

Waltek Testing Group (Shenzhen) Co., Ltd.

Address: 1/F., Room 101, Building 1, Hongwei Industrial Park, Liuxian 2nd Road,
Block 70 Bao'an District, Shenzhen, Guangdong, China

Tel.: +86-755-33663308 Fax.: +86-755-33663309 Email: sem@waltek.com.cn

Tested by:

Approved by:

Mike Shi

Jason Su



TABLE OF CONTENTS

1. GENERAL INFORMATION	4
1.1 PRODUCT DESCRIPTION FOR EQUIPMENT UNDER TEST (EUT).....	4
1.2 TEST STANDARDS	6
1.3 TEST METHODOLOGY.....	6
1.4 TEST FACILITY.....	6
1.5 EUT SETUP AND TEST MODE.....	7
1.6 MEASUREMENT UNCERTAINTY	8
1.7 TEST EQUIPMENT LIST AND DETAILS	9
2. SUMMARY OF TEST RESULTS	13
3. RF OUTPUT POWER	14
3.1 STANDARD APPLICABLE.....	14
3.2 TEST PROCEDURE.....	14
3.3 SUMMARY OF TEST RESULTS.....	15
4. POWER SPECTRAL DENSITY	20
4.1 STANDARD APPLICABLE.....	20
4.2 TEST PROCEDURE.....	20
4.3 SUMMARY OF TEST RESULTS.....	21
5. ADAPTIVITY	25
5.1 STANDARD APPLICATION	25
5.2 TEST PROCEDURE	26
5.3 SUMMARY OF TEST RESULTS/PLOTS	27
6. OCCUPIED CHANNEL BANDWIDTH	35
6.1 STANDARD APPLICATION	35
6.2 TEST PROCEDURE	35
6.3 SUMMARY OF TEST RESULTS/PLOTS	35
7. TRANSMITTER UNWANTED EMISSIONS IN THE OUT-OF-BAND DOMAIN	40
7.1 STANDARD APPLICATION	40
7.2 TEST PROCEDURE	40
7.3 SUMMARY OF TEST RESULTS/PLOTS	42
8. TRANSMITTER UNWANTED EMISSIONS IN THE SPURIOUS DOMAIN	46
8.1 STANDARD APPLICABLE.....	46
8.2 TEST PROCEDURE.....	46
8.3 SUMMARY OF TEST RESULTS/PLOTS	46
9. RECEIVER SPURIOUS EMISSIONS	53
9.1 STANDARD APPLICABLE.....	53
9.2 TEST PROCEDURE.....	53
9.3 SUMMARY OF TEST RESULTS/PLOTS	53
10. RECEIVER BLOCKING	58
10.1 STANDARD APPLICATION.....	58
10.2 TEST PROCEDURE.....	61
10.3 TEST SETUP	61
10.4 SUMMARY OF TEST RESULTS/PLOTS	62
EXHIBIT 1 - EUT PHOTOGRAPHS	63
EXHIBIT 2 - TEST SETUP PHOTOGRAPHS	64



Report version

Version No.	Date of issue	Description
Rev.00	2024-04-12	Original
/	/	/

WALTEK



1. GENERAL INFORMATION

1.1 Product Description for Equipment Under Test (EUT)

General Description of EUT	
Product Name:	CCTV Camera
Trade Name:	/
Model No.:	C6S2X-H
Adding Model(s):	R15, R11, R55, IP1100, IP1150, IP1050, IP820, IPS1300, IPS1200, IP600, C18PRO, C262X, C20, SC01, SC02, SC03, SC05, SC06, SC07, SC20, C6S2, C25, V587, SC08, SC09, C22, C29, SC10
Rated Voltage:	DC12V
Battery Capacity:	/
Power Adapter:	/
Software Version:	/
Hardware Version:	/
<p><i>Note: The test data is gathered from a production sample, provided by the manufacturer. The appearance of others models listed in the report is different from main-test model C6S2X-H, but the circuit and the electronic construction do not change, declared by the manufacturer.</i></p>	

E.1 Product Information (Wi-Fi)	
a) Type of modulation:	<input type="checkbox"/> FHSS <input checked="" type="checkbox"/> other forms of modulation
b) Adaptive / non-adaptive:	Adaptive equipment without a non-adaptive mode
c) In case of adaptive equipment:	The equipment has implemented an LBT based DAA mechanism
d) In case of non-adaptive equipment:	No
e) The worst case operational mode for each of the following tests	
RF output power:	802.11b
Power spectrum density:	802.11b
Occupied channel bandwidth:	802.11n-HT20
Transmitter unwanted emissions in the OOB domain:	802.11b
Transmitter unwanted emissions in the spurious domain:	802.11b
Receiver spurious emissions:	802.11b
f) Operating mode(antenna):	Single Antenna Equipment
g) In case of smart antenna Systems:	No
h) Operating frequency range(s) of the equipment:	2412-2472MHz for 802.11b/g/n(HT20)
i) Occupied channel bandwidth(s):	Bandwidth 1(Min): 13.52MHz



	Bandwidth 2(Max): 18.08MHz
j) Type of equipment:	<input checked="" type="checkbox"/> Stand-alone <input type="checkbox"/> Combined equipment <input type="checkbox"/> Plug-in device
k) The extreme operating conditions	
Extreme voltage range:	Please refer to Section 1.5
Extreme temperature range:	Please refer to Section 1.5
l) The intended combination(s) of the radio equipment power settings and one or more antenna assemblies and their corresponding e.i.r.p levels	
Antenna type:	<input checked="" type="checkbox"/> External Antenna <input type="checkbox"/> Dedicated Antennas
Antenna gain:	4.28dBi
m) Nominal voltage:	Please refer to Section 1.5
n) Describe the test modes available which can facilitate testing:	Please refer to Section 1.5
o) The equipment type	Wi-Fi
E.2 Power Level Setting	
Highest EIRP value:	16.51dBm
Conducted power:	12.23dBm
Listed as power setting:	Default
E.3 Additional Information	
Modulation:	CCK, OFDM, QPSK, BPSK, 16QAM, 64QAM
Unmodulated modes:	No
Duty cycle:	Continuous operation possible for testing purposes
Type of the UUT:	Production models
Supporting equipment provided:	Please refer to Section 1.5
<i>Note: The Antenna Gain is provided by the customer and can affect the validity of results.</i>	



1.2 Test Standards

The tests were performed according to following standards:

ETSI EN 300 328 V2.2.2 (2019-07) Wideband transmission systems; Data transmission equipment operating in the 2,4 GHz band; Harmonised Standard for access to radio spectrum.

Maintenance of compliance is the responsibility of the manufacturer. Any modification of the product maybe which result in lowering the emission/immunity should be checked to ensure compliance has been maintained.

1.3 Test Methodology

All measurements contained in this report were conducted with ETSI EN 300328, the equipment under test (EUT) was configured to measure its highest possible emission level. For more detail refer to the Operating Instructions.

1.4 Test Facility

Address of the test laboratory

Laboratory: Waltek Testing Group (Shenzhen) Co., Ltd.

Address: 1/F., Room 101, Building 1, Hongwei Industrial Park, Liuxian 2nd Road, Block 70 Bao'an District, Shenzhen, Guangdong, China

FCC – Registration No.: 125990

Waltek Testing Group (Shenzhen) Co., Ltd. EMC Laboratory has been registered and fully described in a report filed with the FCC (Federal Communications Commission). The acceptance letter from the FCC is maintained in our files. The Designation Number is CN5010, and Test Firm Registration Number is 125990.

Industry Canada (IC) Registration No.: 11464A

The 3m Semi-anechoic chamber of Waltek Testing Group (Shenzhen) Co., Ltd. has been registered by Certification and Engineering Bureau of Industry Canada for radio equipment testing with Registration No.: 11464A.



1.5 EUT Setup and Test Mode

The equipment under test (EUT) was configured to measure its highest possible emission/immunity level. The test modes were adapted according to the operation manual for use, the EUT was operated in the engineering mode to fix the Tx/Rx frequency that was for the purpose of the measurements, more detailed description as follows:

Test Mode List		
Test Mode	Description	Remark
TM1	802.11b	2412MHz, 2442MHz, 2472MHz
TM2	802.11g	2412MHz, 2442MHz, 2472MHz
TM3	802.11n-HT20	2412MHz, 2442MHz, 2472MHz
TM4	Receiving	/

Note: The product is a Load Based Equipment, The value of q is selected by the manufacturer is 32

	NTNV	LTVN	HTNV
Temperature (°C)	25	-10	+50
Voltage (VDC)	12		
Relative Humidity:		45 %.	
ATM Pressure:		1019 mbar	

EUT Cable List and Details			
Cable Description	Length (m)	Shielded/Unshielded	With / Without Ferrite
/	/	/	/

Accessories Cable List and Details			
Cable Description	Length (m)	Shielded/Unshielded	With / Without Ferrite
DC CABLE	1.0	Unshielded	Without Ferrite
RJ45	1.5	Unshielded	Without Ferrite

Auxiliary Equipment List and Details			
Description	Manufacturer	Model	Serial Number
Adapter	/	RJT-AS120300C301	/
Computer	Lenovo	L13 Yoga	/
Wireless Router	TP-LINK	TL-WR842N	/



1.6 Measurement Uncertainty

Measurement uncertainty		
Parameter	Uncertainty	Note
Radio frequency	$\pm 0.4\text{ppm}$	(1)
Conducted RF Output Power	$\pm 0.42\text{dB}$	(1)
Occupied Bandwidth	$\pm 1 \times 10^{-7}$	(1)
Conducted Power Spectral Density	$\pm 0.70\text{dB}$	(1)
Conducted Spurious Emission	$\pm 2.17\text{dB}$	(1)
Radiated Spurious Emissions	30-200MHz $\pm 4.52\text{dB}$	(1)
	0.2-1GHz $\pm 5.56\text{dB}$	(1)
	1-6GHz $\pm 3.84\text{dB}$	(1)
	6-18GHz $\pm 3.92\text{dB}$	(1)

(1) This uncertainty represents an expanded uncertainty expressed at approximately the 95% confidence level using a coverage factor of $k=1.96$.

WALTEK



1.7 Test Equipment List and Details

Description	Manufacturer	Model	Serial Number	Cal Date	Due Date
Spectrum Analyzer	Agilent	N9020A	US47140102	2023-02-25	2024-02-24
Signal Generator	Agilent	83752A	3610A01453	2023-02-25	2024-02-24
Vector Signal Generator	Agilent	N5182A	MY47070202	2023-02-25	2024-02-24
Power Sensor	Agilent	U2021XA	MY54250019	2023-02-25	2024-02-24
Power Sensor	Agilent	U2021XA	MY54250021	2023-02-25	2024-02-24
Simultaneous Sampling	Agilent	U2531A	TW54243509	2023-02-25	2024-02-24
Communication Tester	HP	8921A	/	2023-02-25	2024-02-24
Temperature&Humidity Chamber	/	HTC-1	/	2023-02-25	2024-02-24
Universal Radio Communication Tester	Rohde & Schwarz	CMW500	148650	2023-02-25	2024-02-24
<input checked="" type="checkbox"/> Chamber A: Below 1GHz					
Spectrum Analyzer	Rohde & Schwarz	FSP30	836079/035	2023-02-25	2024-02-24
EMI Test Receiver	Rohde & Schwarz	ESVB	825471/005	2023-02-25	2024-02-24
Amplifier	HP	8447F	2805A03475	2023-02-25	2024-02-24
Loop Antenna	Schwarz beck	FMZB 1516	9773	2021-03-20	2024-03-19
Trilog Broadband Antenna	Schwarz beck	VULB9163	9163-333	2023-03-20	2026-03-19
<input checked="" type="checkbox"/> Chamber A: Above 1GHz					
Spectrum Analyzer	Rohde & Schwarz	FSP30	836079/035	2023-02-25	2024-02-24
Spectrum Analyzer	Rohde & Schwarz	FSP40	100612	2023-02-25	2024-02-24
EMI Test Receiver	Rohde & Schwarz	ESVB	825471/005	2023-02-25	2024-02-24
Amplifier	C&D	PAP-1G18	14918	2023-02-25	2024-02-24
Horn Antenna	ETS	3117	00086197	2021-03-19	2024-03-18
DRG Horn Antenna	A.H. SYSTEMS	SAS-574	571	2021-03-19	2024-03-18
Pre-amplifier	Schwarzbeck	BBV 9721	9721-031	2023-02-25	2024-02-24
<input type="checkbox"/> Chamber B:Below 1GHz					
Trilog Broadband Antenna	Schwarz beck	VULB9163(B)	9163-635	2021-04-09	2024-04-08
Amplifier	Agilent	8447D	2944A10457	2023-02-25	2024-02-24
EMI Test Receiver	Rohde & Schwarz	ESPI	101391	2023-02-25	2024-02-24
<input type="checkbox"/> Chamber C:Below 1GHz					
EMI Test Receiver	Rohde & Schwarz	ESIB 26	100401	2023-02-25	2024-02-24
Trilog Broadband Antenna	Schwarz beck	VULB 9168	1194	2021-05-28	2024-05-27
Loop Antenna	Schwarz beck	FMZB 1516	9773	2021-03-20	2024-03-19



Amplifier	HP	8447F	2944A03869	2023-02-25	2024-02-24
<input type="checkbox"/> Chamber C: Above 1GHz					
EMI Test Receiver	Rohde & Schwarz	ESIB 26	100401	2023-02-25	2024-02-24
Horn Antenna	POAM	RTF-118A	1820	2023-03-10	2026-03-09
Amplifier	Tonscend	TAP01018050	AP22E806235	2023-02-25	2024-02-24
DRG Horn Antenna	A.H. SYSTEMS	SAS-574	571	2021-03-19	2024-03-18
Pre-amplifier	Schwarzbeck	BBV 9721	9721-031	2023-02-25	2024-02-24

WALTEK



Description	Manufacturer	Model	Serial Number	Cal Date	Due Date
Spectrum Analyzer	Agilent	N9020A	US47140102	2024-03-19	2025-03-18
Signal Generator	Agilent	83752A	3610A01453	2024-02-24	2025-02-23
Vector Signal Generator	Agilent	N5182A	MY47070202	2024-02-24	2025-02-23
Power Sensor	Agilent	U2021XA	MY54250019	2024-02-24	2025-02-23
Power Sensor	Agilent	U2021XA	MY54250021	2024-02-24	2025-02-23
Simultaneous Sampling	Agilent	U2531A	TW54243509	2024-02-24	2025-02-23
Temperature&Humidity Chamber	/	HTC-1	/	2024-02-24	2025-02-23
Universal Radio Communication Tester	Rohde & Schwarz	CMW500	148650	2024-02-24	2025-02-23
<input checked="" type="checkbox"/> Chamber A: Below 1GHz					
Spectrum Analyzer	Rohde & Schwarz	FSP30	836079/035	2024-02-24	2025-02-23
EMI Test Receiver	Rohde & Schwarz	ESPI	101611	2024-03-19	2025-03-18
Amplifier	HP	8447F	2805A03475	2024-02-24	2025-02-23
Loop Antenna	Schwarz beck	FMZB 1516	9773	2024-02-26	2025-02-25
Broadband Antenna	Schwarz beck	VULB9163	9163-333	2024-02-24	2025-02-23
<input checked="" type="checkbox"/> Chamber A: Above 1GHz					
Spectrum Analyzer	Rohde & Schwarz	FSP30	836079/035	2024-02-24	2025-02-23
Spectrum Analyzer	Rohde & Schwarz	FSP40	100612	2024-02-27	2025-02-26
EMI Test Receiver	Rohde & Schwarz	ESPI	101611	2024-03-19	2025-03-18
Amplifier	C&D	PAP-1G18	2002	2024-02-27	2025-02-26
Horn Antenna	ETS	3117	00086197	2024-02-26	2025-02-25
DRG Horn Antenna	A.H. SYSTEMS	SAS-574	571	2024-03-17	2025-03-16
Pre-amplifier	Schwarzbeck	BBV 9721	9721-031	2024-02-29	2025-02-28
<input type="checkbox"/> Chamber B:Below 1GHz					
Trilog Broadband Antenna	Schwarz beck	VULB9163(B)	9163-635	2024-03-17	2027-03-16
Amplifier	Agilent	8447D	2944A10179	2024-02-24	2025-02-23
EMI Test Receiver	Rohde & Schwarz	ESPI	101391	2024-02-24	2025-02-23
<input type="checkbox"/> Chamber C:Below 1GHz					
EMI Test Receiver	Rohde & Schwarz	ESIB 26	100401	2024-02-27	2025-02-26
Trilog Broadband Antenna	Schwarz beck	VULB 9168	1194	2021-05-28	2024-05-27
Loop Antenna	Schwarz beck	FMZB 1516	9773	2024-02-26	2025-02-25
Amplifier	HP	8447F	2944A03869	2024-02-24	2025-02-23
<input type="checkbox"/> Chamber C: Above 1GHz					



EMI Test Receiver	Rohde & Schwarz	ESIB 26	100401	2024-02-27	2025-02-26
Horn Antenna	POAM	RTF-118A	1820	2023-03-10	2026-03-09
Amplifier	Tonscend	TAP01018050	AP22E806235	2024-02-27	2025-02-26
DRG Horn Antenna	A.H. SYSTEMS	SAS-574	571	2024-03-17	2025-03-16
Pre-amplifier	Schwarzbeck	BBV 9721	9721-031	2024-02-29	2025-02-28

Software List			
Description	Manufacturer	Model	Version
EMI Test Software (Radiated Emission)*	Farad	EZ-EMC	RA-03A1
RF Test System	TST	TST-258	V2.0
RF Test System	Ascentest	AT890	V3.0

*Remark: indicates software version used in the compliance certification testing

WALTEK



2. SUMMARY OF TEST RESULTS

Standards	Reference	Description of Test Item	Result
EN 300 328	4.3.2.2	RF Output Power	Passed
	4.3.2.3	Power Spectral Density	Passed
	4.3.2.4	Duty Cycle, Tx-sequence, Tx-gap	N/A
	4.3.2.5	Medium Utilisation (MU) Factor	N/A
	4.3.2.6	Adaptivity (adaptive equipment using modulations other than FHSS)	Passed
	4.3.2.7	Occupied Channel Bandwidth	Passed
	4.3.2.8	Transmitter Unwanted Emissions in the Out-of-band Domain	Passed
	4.3.2.9	Transmitter Unwanted Emissions in the Spurious Domain	Passed
	4.3.2.10	Receiver Spurious Emissions	Passed
	4.3.2.11	Receiver Blocking	Passed
	4.3.2.12	Geo-location capability	N/A

Passed: The EUT complies with the essential requirements in the standard.
 Failed: The EUT does not comply with the essential requirements in the standard.
 N/A: not applicable.



3. RF Output Power

3.1 Standard Applicable

According to Section 4.3.1.2.3, the maximum RF output power for adaptive Frequency Hopping equipment shall be equal to or less than 20 dBm. The maximum RF output power for non-adaptive Frequency Hopping equipment, shall be declared by the supplier. The maximum RF output power for this equipment shall be equal to or less than the value declared by the supplier. This declared value shall be equal to or less than 20dBm.

According to Section 4.3.2.2.3, For adaptive equipment using wide band modulations other than FHSS, the maximum RF output power shall be 20 dBm. The maximum RF output power for non-adaptive equipment shall be declared by the supplier and shall not exceed 20 dBm. For non-adaptive equipment using wide band modulations other than FHSS, the maximum RF output power shall be equal to or less than the value declared by the supplier.

3.2 Test Procedure

According to section 5.4.2.2.1.2 of the standard EN 300328, the test procedure shall be as follows:

Step 1:

- Use a fast power sensor suitable for 2.4 GHz and capable of 1MS/s.
- Use the following settings: - Sample speed 1 MS/s or faster.
- The samples must represent the power of the signal.
- Measurement duration: For non-adaptive equipment: equal to the observation period defined in clauses 4.3.1.3.2 or clause 4.3.2.4.2. For adaptive equipment, the measurement duration shall be long enough to ensure a minimum number of bursts (at least 10) are captured.

NOTE 1: For adaptive equipment, to increase the measurement accuracy, a higher number of bursts may be used.

Step 2:

- For conducted measurements on devices with one transmit chain:
 - Connect the power sensor to the transmit port, sample the transmit signal and store the raw data. Use these stored samples in all following steps.
- For conducted measurements on devices with multiple transmit chains:
 - Connect one power sensor to each transmit port for a synchronous measurement on all transmit ports.
 - Trigger the power sensors so that they start sampling at the same time. Make sure the time difference between the samples of all sensors is less than half the time between two samples.
 - For each individual sampling point (time domain), sum the coincident power samples of all ports and store them. Use these summed samples in all following steps..



Reference No.: WTX24X01018378W001

Step 3:

- Find the start and stop times of each burst in the stored measurement samples.

The start and stop times are defined as the points where the power is at least 30 dB below the highest value of the stored samples in step 2.

NOTE 2: In case of insufficient dynamic range, the value of 30 dB may need to be reduced appropriately.

Step 4:

- Between the start and stop times of each individual burst calculate the RMS power over the burst using the formula below. Save these Pburst values, as well as the start and stop times for each burst.

$$P_{burst} = \frac{1}{k} \sum_{n=1}^k P_{sample}(n)$$

with 'k' being the total number of samples and 'n' the actual sample number

Step 5:

- The highest of all Pburst values (value "A" in dBm) will be used for maximum e.i.r.p. calculations.

Step 6:

- Add the (stated) antenna assembly gain "G" in dBi of the individual antenna.
- If applicable, add the additional beamforming gain "Y" in dB.
- If more than one antenna assembly is intended for this power setting, the maximum overall antenna gain (G or G + Y) shall be used.
- The RF Output Power (P) shall be calculated using the formula below: $P = A + G + Y$
- This value, which shall comply with the limit given in clause 4.3.1.2.3 or clause 4.3.2.2.3, shall be recorded in the test report.

3.3 Summary of Test Results



Test Conditions	EIRP (dBm)			Limit dBm
	Lowest CH	Middle CH	Highest CH	
802.11b				
NTNV	16.51	16.33	15.88	20
LTVN	16.42	16.23	15.83	20
HTNV	16.42	16.25	15.78	20
802.11g				
NTNV	15.31	15.50	14.68	20
LTVN	15.22	15.43	14.60	20
HTNV	15.25	15.42	14.61	20
802.11n HT20				
NTNV	14.24	14.72	14.31	20
LTVN	14.16	14.66	14.25	20
HTNV	14.15	14.66	14.24	20

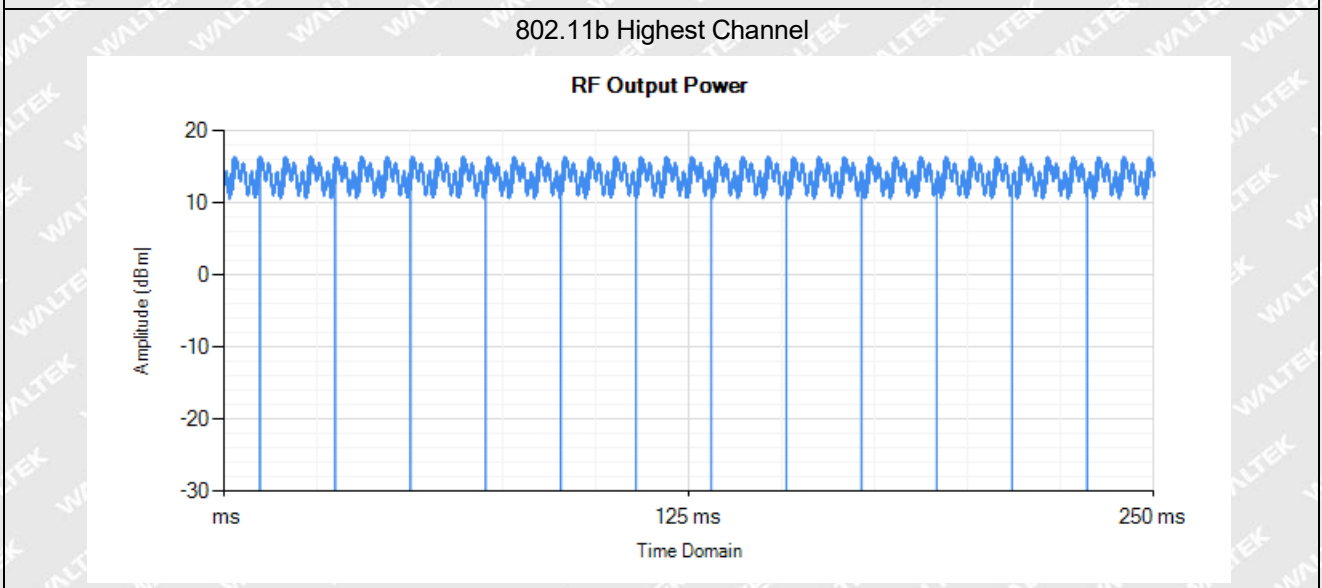
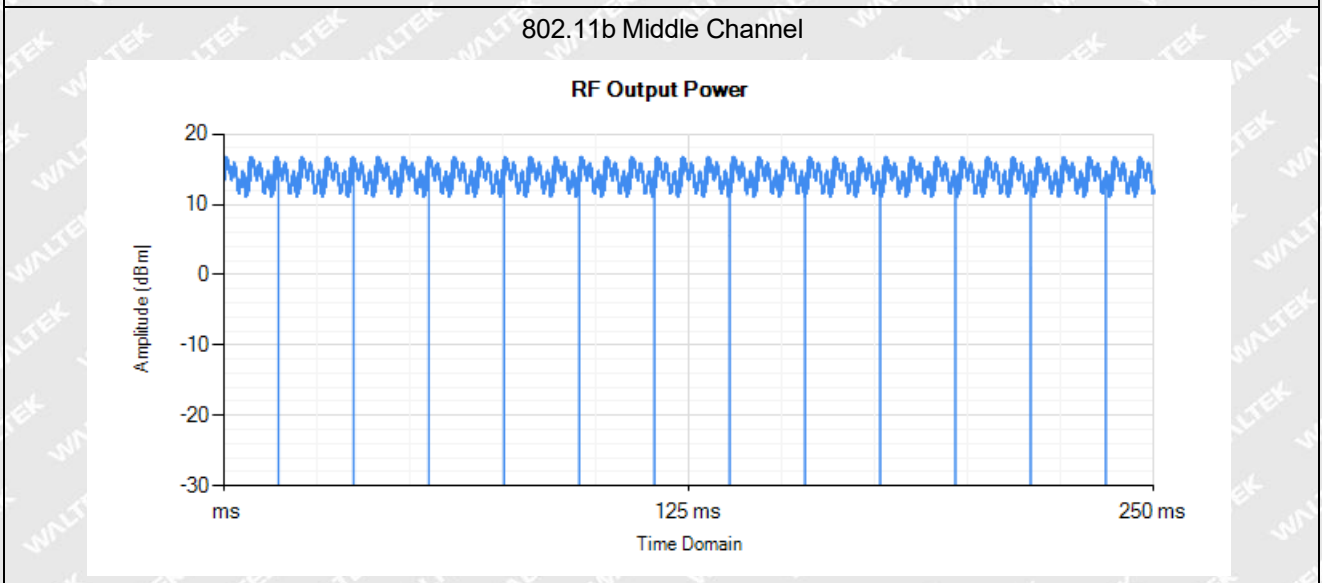
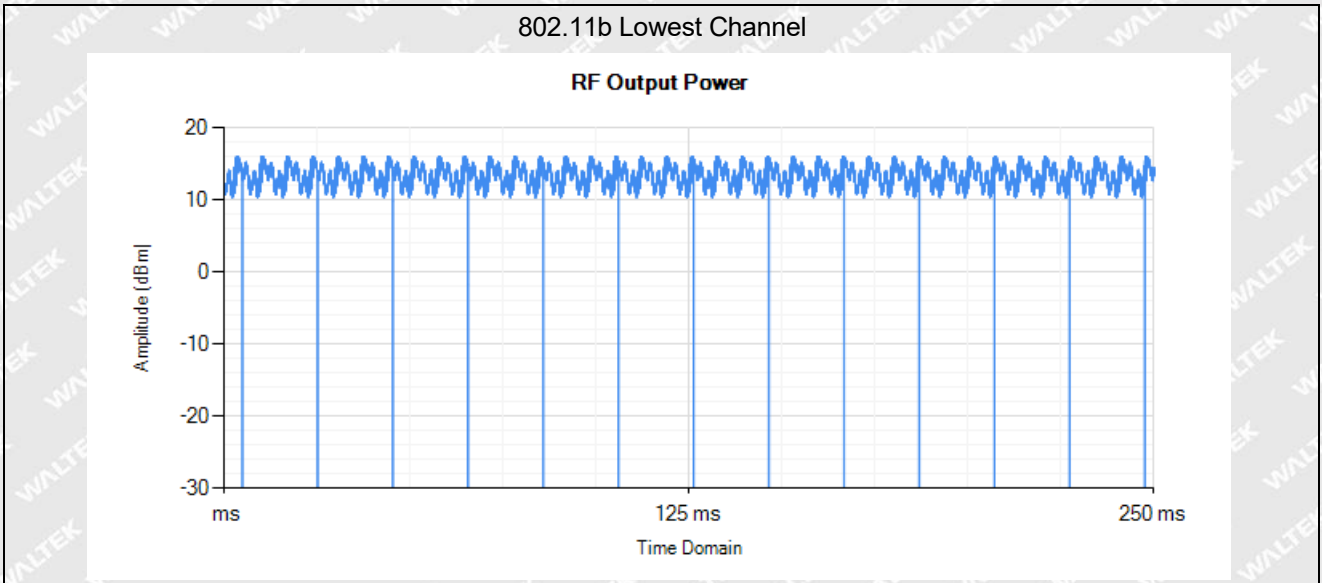

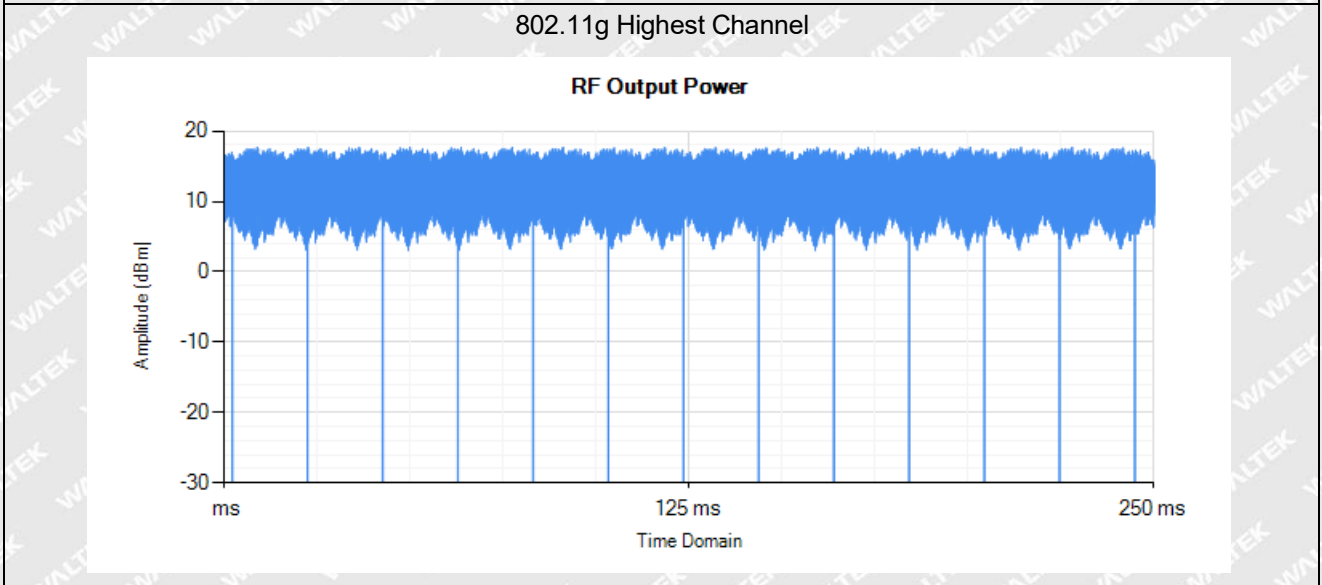
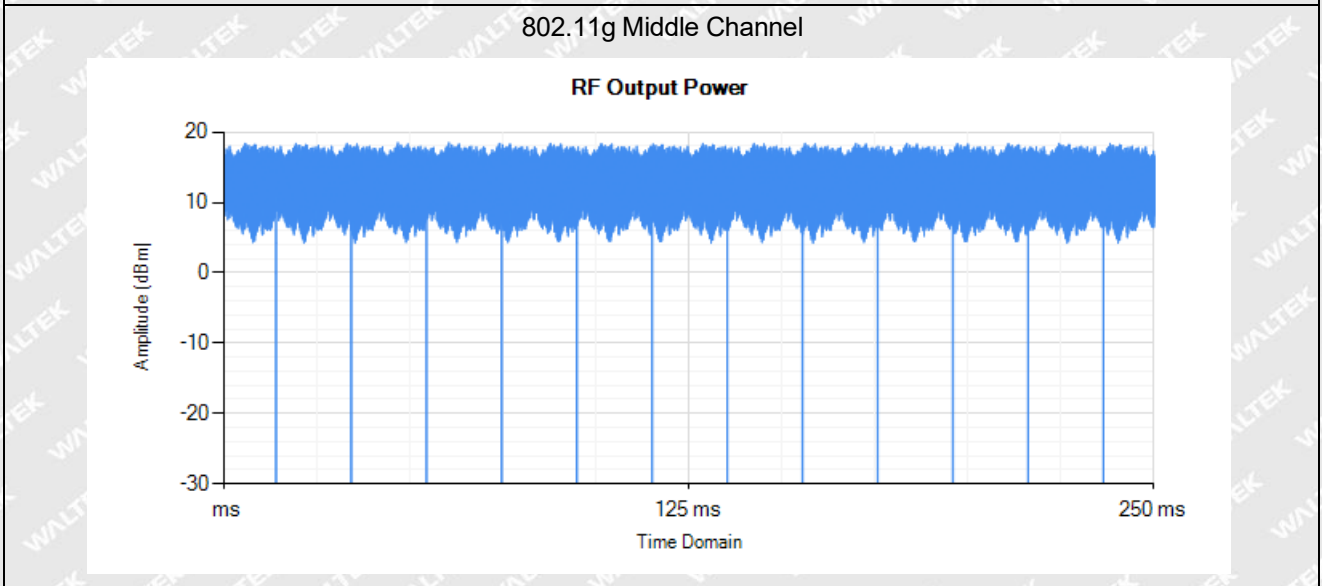
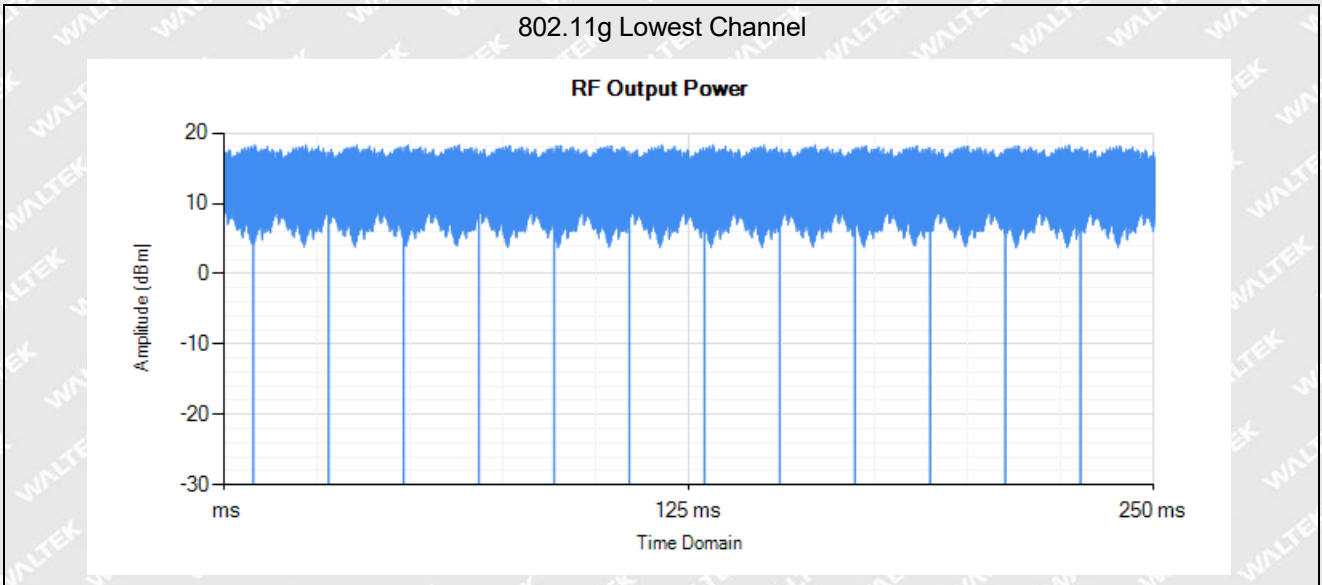



802.11n HT20 Lowest Channel

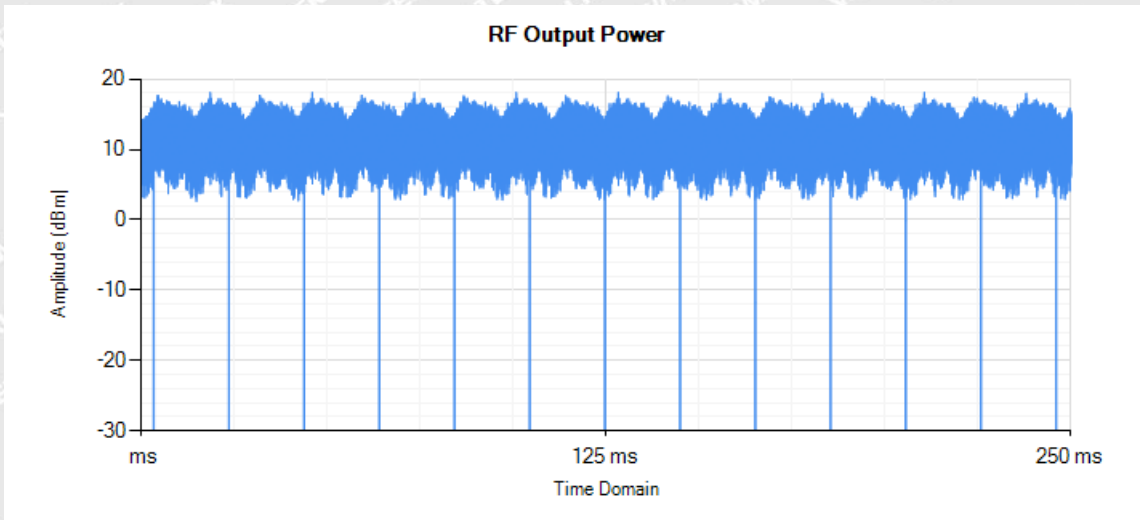

802.11n HT20 Middle Channel

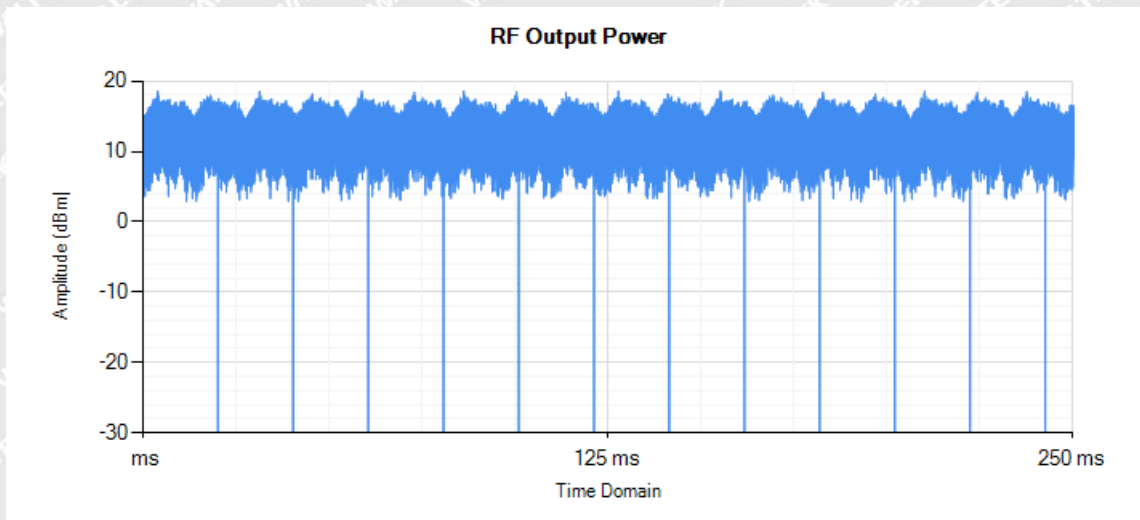

802.11n HT20 Highest Channel

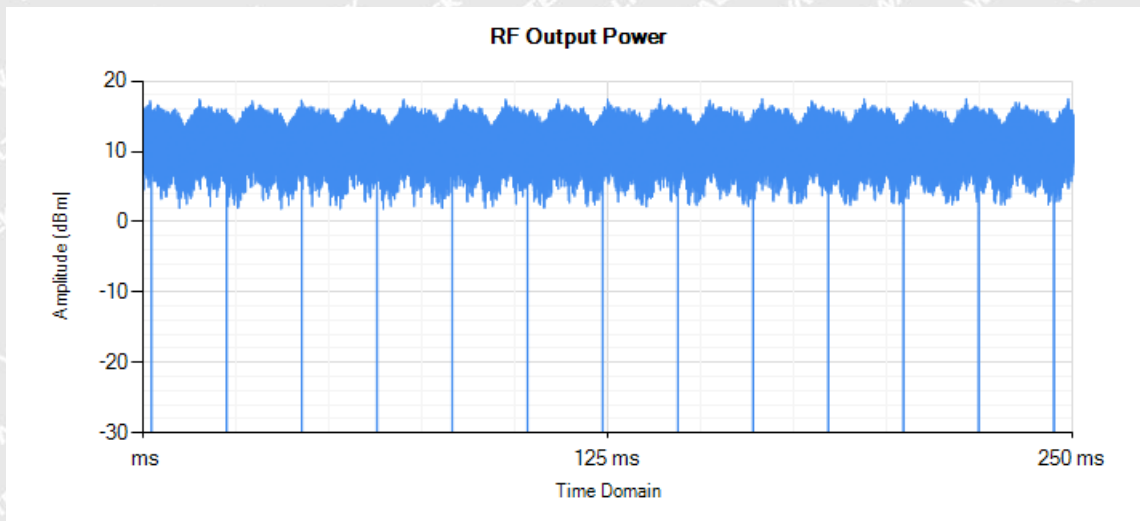



4. Power Spectral Density

4.1 Standard Applicable

According to Section 4.3.2.3.3, for equipment using wide band modulations other than FHSS, the maximum Power Spectral Density is limited to 10 dBm per MHz.

4.2 Test Procedure

According to section 5.4.3.2.1 of the standard EN 300328, the test procedure shall be as follows:

Step 1:

Connect the UUT to the spectrum analyser and use the following settings:

- Start Frequency: 2 400 MHz
- Stop Frequency: 2 483,5 MHz
- Resolution BW: 10 kHz
- Video BW: 30 kHz
- Sweep Points: > 8 350

NOTE: For spectrum analysers not supporting this number of sweep points, the frequency band may be segmented.

- Detector: RMS
- Trace Mode: Max Hold
- Sweep time: Auto

For non-continuous signals, wait for the trace to be completed. Save the (trace) data set to a file.

Step 2:

For conducted measurements on smart antenna systems using either operating mode 2 or 3 (see clause 5.1.3.2), repeat the measurement for each of the transmit ports. For each frequency point, add up the amplitude (power) values for the different transmit chains and use this as the new data set.

Step 3:

Add up the values for amplitude (power) for all the samples in the file.

Step 4:

Normalize the individual values for amplitude so that the sum is equal to the RF Output Power (e.i.r.p.) measured in clause 5.3.2.

Step 5:

Starting from the first sample in the file (lowest frequency), add up the power of the following samples representing a 1 MHz segment and record the results for power and position (i.e. sample #1 to #100). This is the Power Spectral Density (e.i.r.p.) for the first 1 MHz segment which shall be recorded.



Reference No.: WTX24X01018378W001

Step 6:

Shift the start point of the samples added up in step 5 by 1 sample and repeat the procedure in step 5 (i.e. sample #2 to #101).

Step 7:

Repeat step 6 until the end of the data set and record the radiated Power Spectral Density values for each of the 1 MHz segments.

From all the recorded results, the highest value is the maximum Power Spectral Density for the UUT. This value, which shall comply with the limit given in clause 4.3.2.3.3, shall be recorded in the test report.

RBW/VBW=10/30 kHz

4.3 Summary of Test Results

Test Mode	Test Frequency	Spectral Density	Limit
	MHz	dBm/MHz	dBm/MHz
802.11b	2412	8.35	10
	2442	8.18	10
	2472	7.74	10
802.11g	2412	3.91	10
	2442	4.15	10
	2472	3.86	10
802.11n (HT20)	2412	2.42	10
	2442	3.36	10
	2472	2.39	10

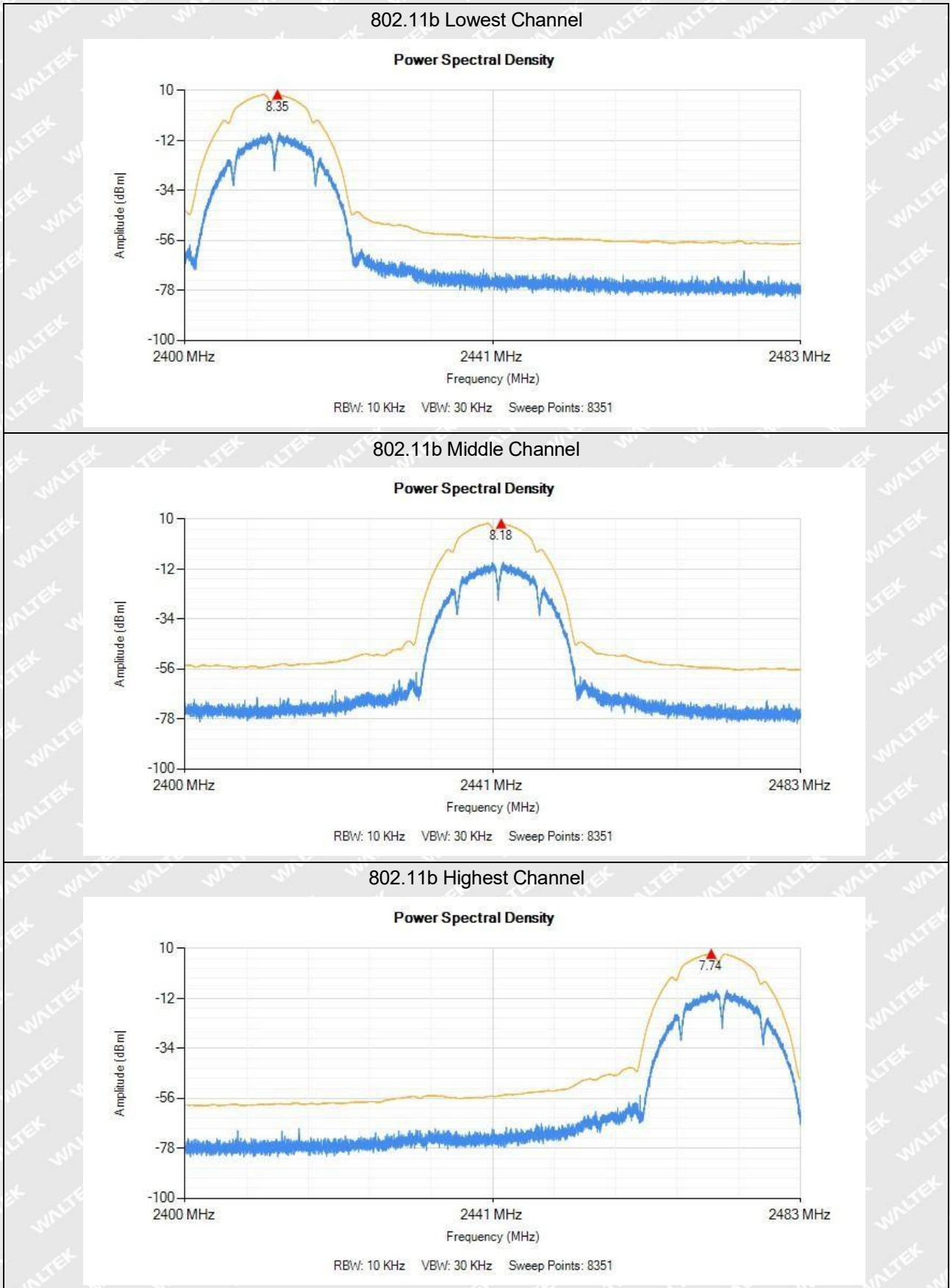

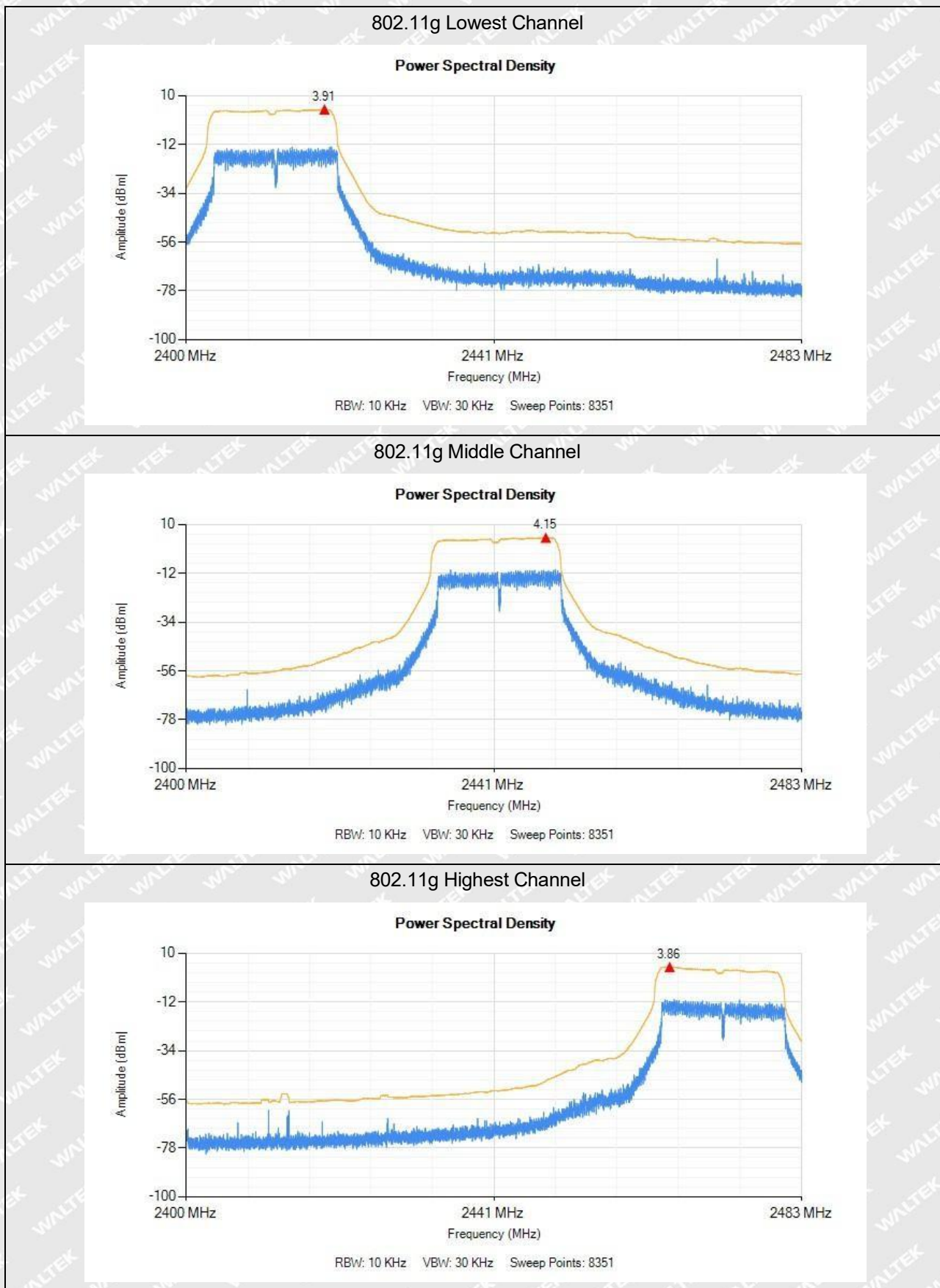



802.11n HT20 Lowest Channel



802.11n HT20 Middle Channel



802.11n HT20 Highest Channel

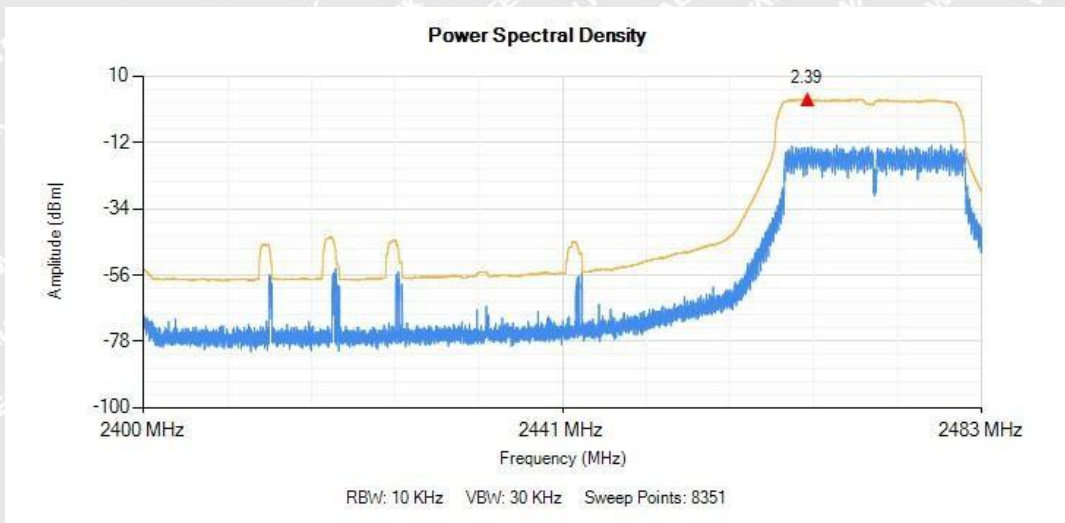



5. Adaptivity

5.1 Standard Application

According to section 4.3.2.6.2.2.2, Load Based Equipment shall comply with the following requirements:
Load Based Equipment may implement an LBT based spectrum sharing mechanism based on the Clear Channel

Assessment (CCA) mode using energy detect, as described in IEEE Std. 802.11™-2007 [i.4] clauses 9, 15, 18 or 19, in IEEE Std. 802.11n™-2009 [i.4], clauses 9, 11 and 20 or in IEEE Std. 802.15.4™-2011 [i.5], clauses 4 and 5 providing they comply with the conformance requirements referred to in clause 4.3.2.6.3.2.

Equipment using a modulation other than FHSS and using the non-LBT based Detect and Avoid mechanism, shall comply with the following minimum set of requirements:

- 1) During normal operation, the equipment shall evaluate the presence of a signal on its current operating channel. If it is determined that a signal is present with a level above the detection threshold defined in step 5) the channel shall be marked as 'unavailable'.
- 2) The channel shall remain unavailable for a minimum time equal to 1 s after which the channel may be considered again as an 'available' channel.
- 3) The total time during which an equipment has transmissions on a given channel without re-evaluating the availability of that channel, is defined as the Channel Occupancy Time.
- 4) The Channel Occupancy Time shall be less than 40 ms. Each such transmission sequence shall be followed by an Idle Period (no transmissions) of minimum 5 % of the Channel Occupancy Time with a minimum of 100 μs. After this, the procedure as in step 1) needs to be repeated.
- 5) The detection threshold shall be proportional to the transmit power of the transmitter: for a 20 dBm e.i.r.p. transmitter the detection threshold level (TL) shall be equal to or less than -70 dBm/MHz at the input to the receiver (assuming a 0 dBi receive antenna). For power levels less than 20 dBm e.i.r.p., the detection threshold level may be relaxed to: $TL = -70 \text{ dBm/MHz} + 10 \times \log_{10}(100 \text{ mW} / P_{out})$ (P_{out} in mW e.i.r.p.)
- 6) The equipment shall comply with the requirements defined in step 1) to step 4) of the present clause in the presence of an unwanted CW signal as defined in table 9.

Non-LBT based Detect and Avoid:

Table 9: Unwanted Signal parameters

Wanted signal mean power from companion device (dBm)	Unwanted signal frequency (MHz)	Unwanted CW signal power (dBm)
-30	2395 or 2488.5 (see note 1)	-35 (see note 2)



Reference No.: WTX24X01018378W001

NOTE 1: The highest frequency shall be used for testing operating channels within the range 2400 MHz to 2442 MHz, while the lowest frequency shall be used for testing operating channels within the range 2442 MHz to 2483.5MHz. See clause 5.4.6.1.

NOTE 2: The level specified is the level in front of the UUT antenna. In case of conducted measurements, this level has to be corrected by the actual antenna assembly gain.

LBT based Detect and Avoid:

Table 10: Unwanted Signal parameters

Wanted signal mean power from companion device	Unwanted signal frequency (MHz)	Unwanted signal power (dBm)
sufficient to maintain the link (see note 2)	2395 or 2 488,5 (see note 1)	-35 (see note 3)

NOTE 1: The highest frequency shall be used for testing operating channels within the range 2400MHz to 2442MHz, while the lowest frequency shall be used for testing operating channels within the range 2442MHz to 2 483.5MHz. See clause 5.4.6.1.

NOTE 2: A typical value which can be used in most cases is -50dBm/MHz.

NOTE 3: The level specified is the level in front of the UUT antenna. In case of conducted measurements, this

5.2 Test procedure

According to the section 5.4.6.2.1, the test block diagram shall be used.

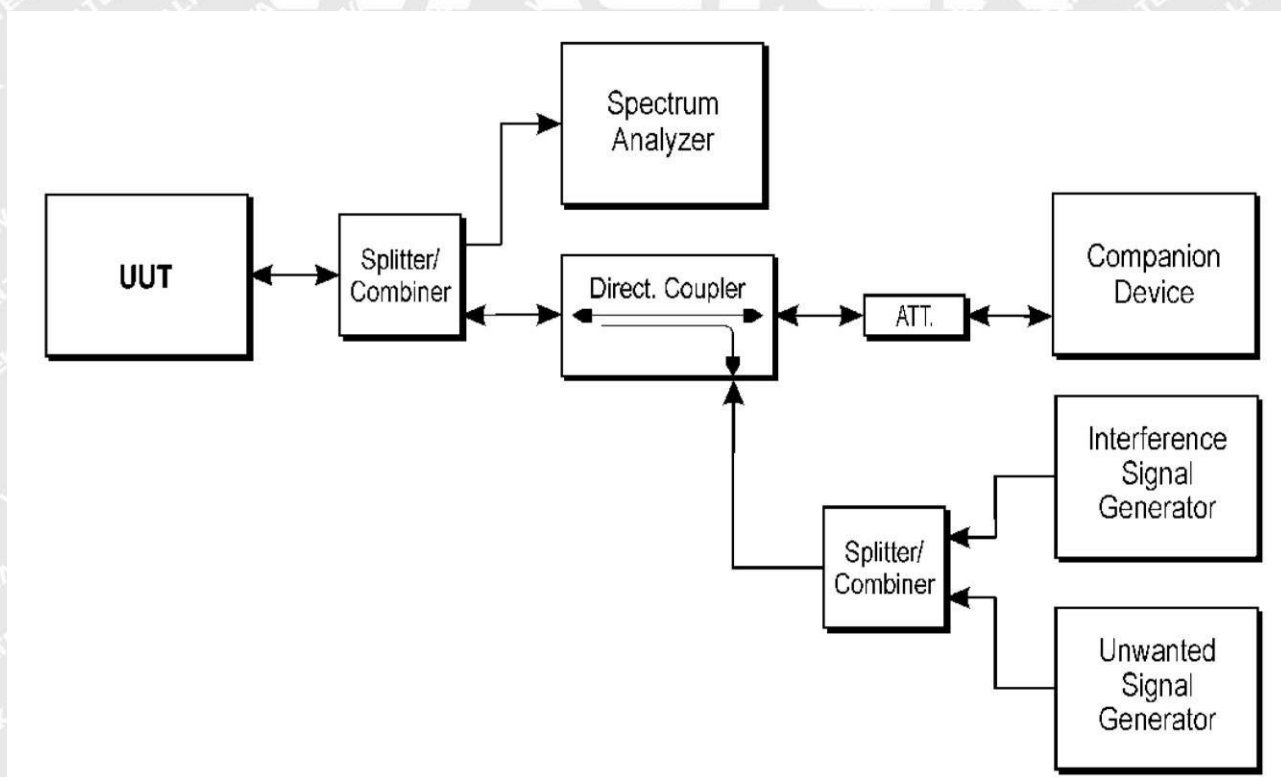



Reference No.: WTX24X01018378W001

All test procedure is carried to the section 5.4.6.2.1

RBW/VBW=8MHz/30MHz

5.3 Summary of Test Results/Plots

AWGN Interference Level (dBm) = -70 dBm/MHz + 10 ×log10 (100 mW / Pout) (Pout in mW e.i.r.p.)

802.11b Lowest Channel (2412MHz)	
AWGN Interference Level (dBm)	-66.51
Block Signal Level (dBm)	-35.00
Max COT Time (ms)	0.42
Interference Start Time (ms)	10000
Minimum Idle time (ms)	1.02
Duty Cycle (%)	0
Pulse Width (ms)	0.00
Block Signal Inject time(ms)	70000
802.11b Highest Channel (2472MHz)	
AWGN Interference Level (dBm)	-65.88
Block Signal Level (dBm)	-35.00
Max COT Time (ms)	0.31
Interference Start Time (ms)	10000
Minimum Idle time (ms)	1.01
Duty Cycle (%)	0
Pulse Width (ms)	0.00
Block Signal Inject time(ms)	70000
802.11g Lowest Channel (2412MHz)	
AWGN Interference Level (dBm)	-65.31
Block Signal Level (dBm)	-35.00
Max COT Time (ms)	0.05
Interference Start Time (ms)	10000
Minimum Idle time (ms)	0.25
Duty Cycle (%)	0
Pulse Width (ms)	0.00
Block Signal Inject time(ms)	70000
802.11g Highest Channel (2472MHz)	
AWGN Interference Level (dBm)	-64.68
Block Signal Level (dBm)	-35.00
Max COT Time (ms)	0.41
Interference Start Time (ms)	10000
Minimum Idle time (ms)	0.05
Duty Cycle (%)	0
Pulse Width (ms)	0.00
Block Signal Inject time(ms)	70000



802.1n-HT20 Lowest Channel (2412MHz)	
AWGN Interference Level (dBm)	-64.24
Block Signal Level (dBm)	-35.00
Max COT Time (ms)	0.05
Interference Start Time (ms)	10000
Minimum Idle time (ms)	0.30
Duty Cycle (%)	0
Pulse Width (ms)	0.00
Block Signal Inject time(ms)	70000
802.11n-HT20 highest Channel (2472MHz)	
AWGN Interference Level (dBm)	-64.31
Block Signal Level (dBm)	-35.00
Max COT Time (ms)	0.05
Interference Start Time (ms)	10000
Minimum Idle time (ms)	0.28
Duty Cycle (%)	0
Pulse Width (ms)	0.00
Block Signal Inject time(ms)	70000

WALTEK



802.11b Lowest Channel (2412MHz)

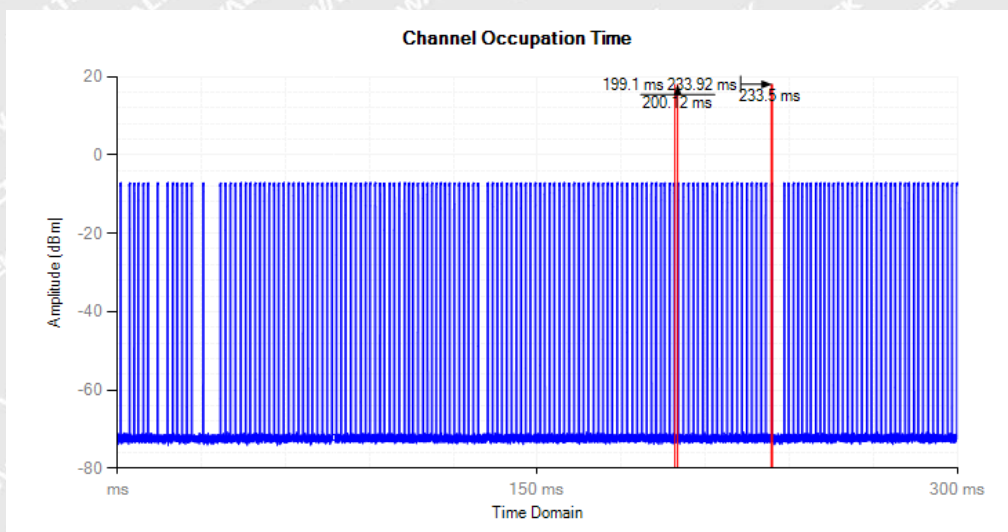
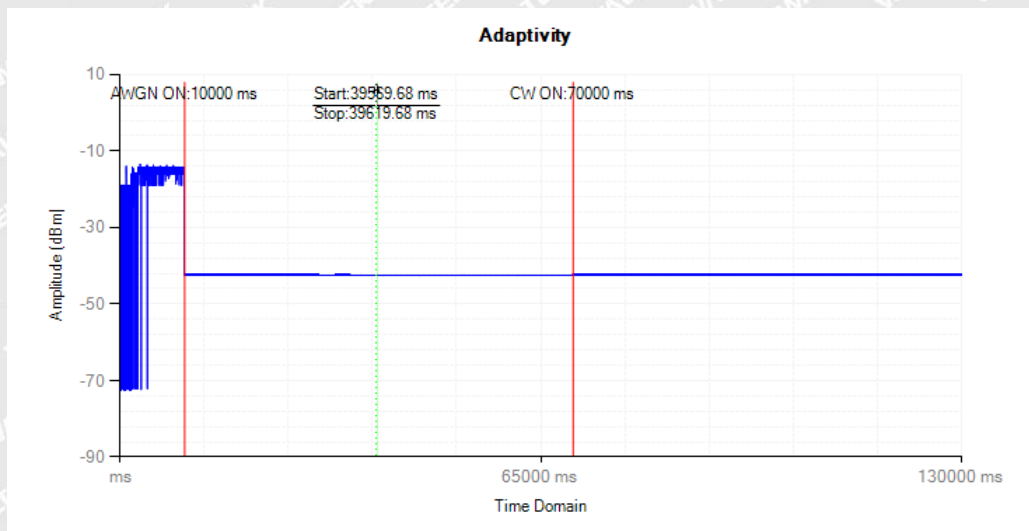



802.11b Highest Channel (2472MHz)

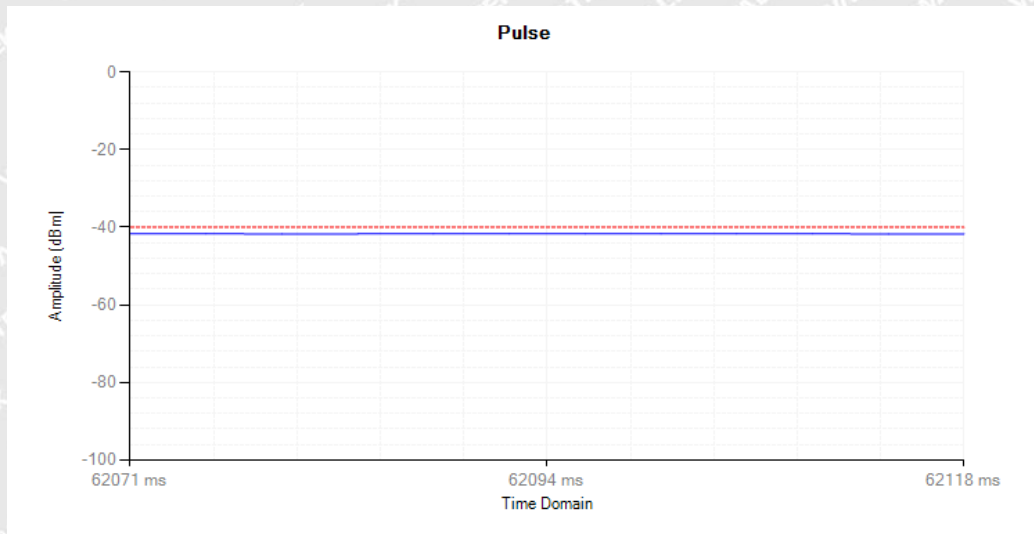
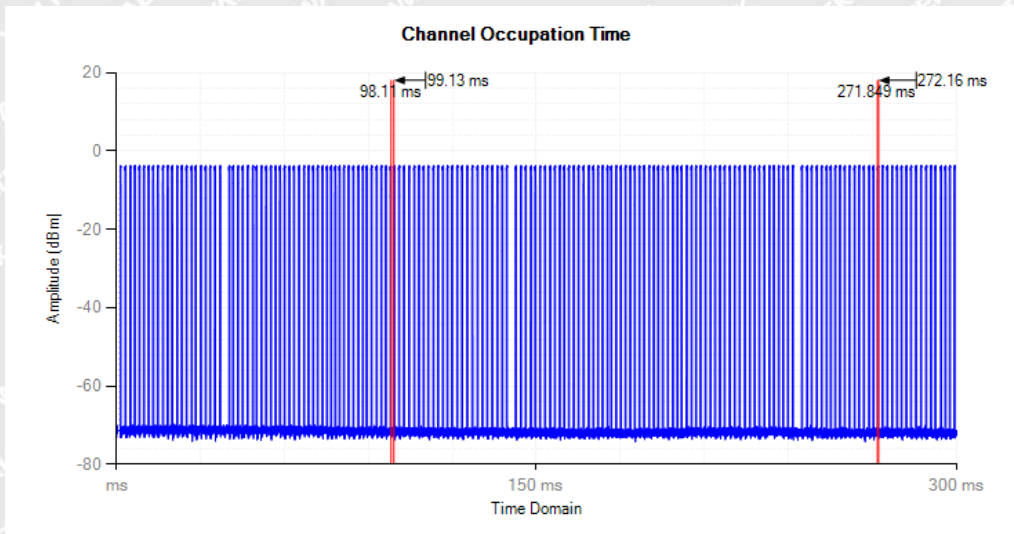
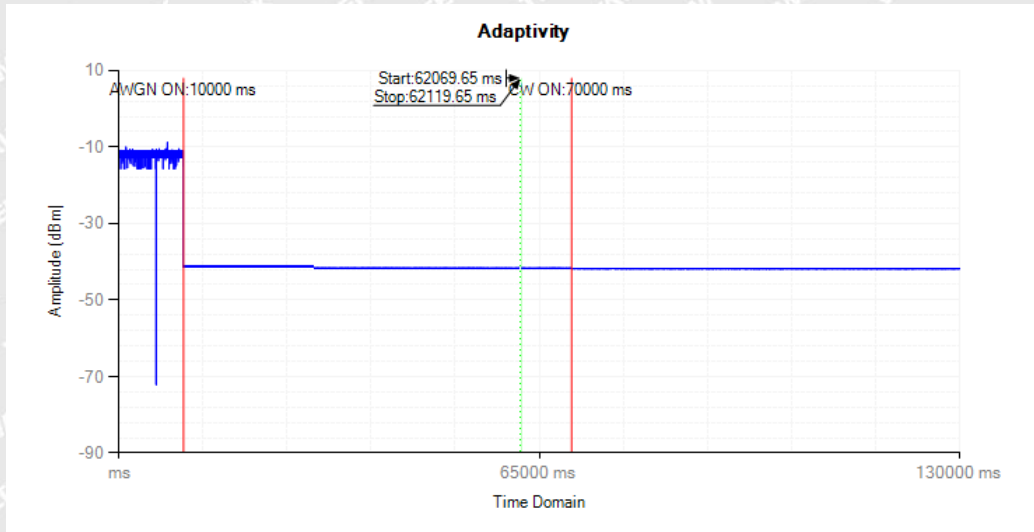

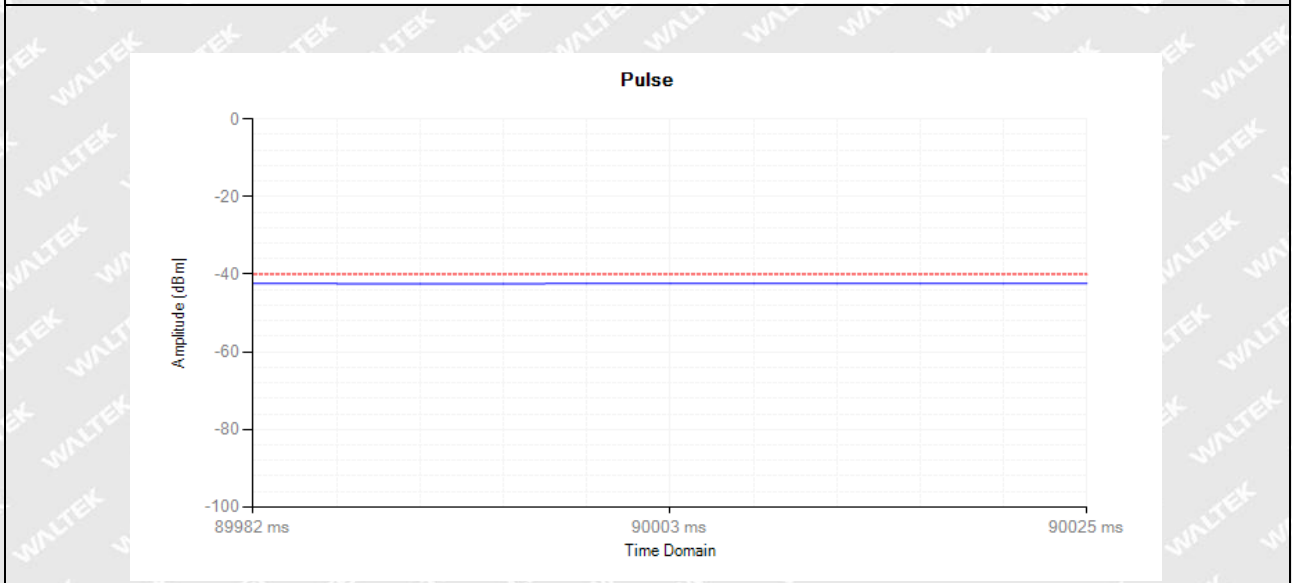
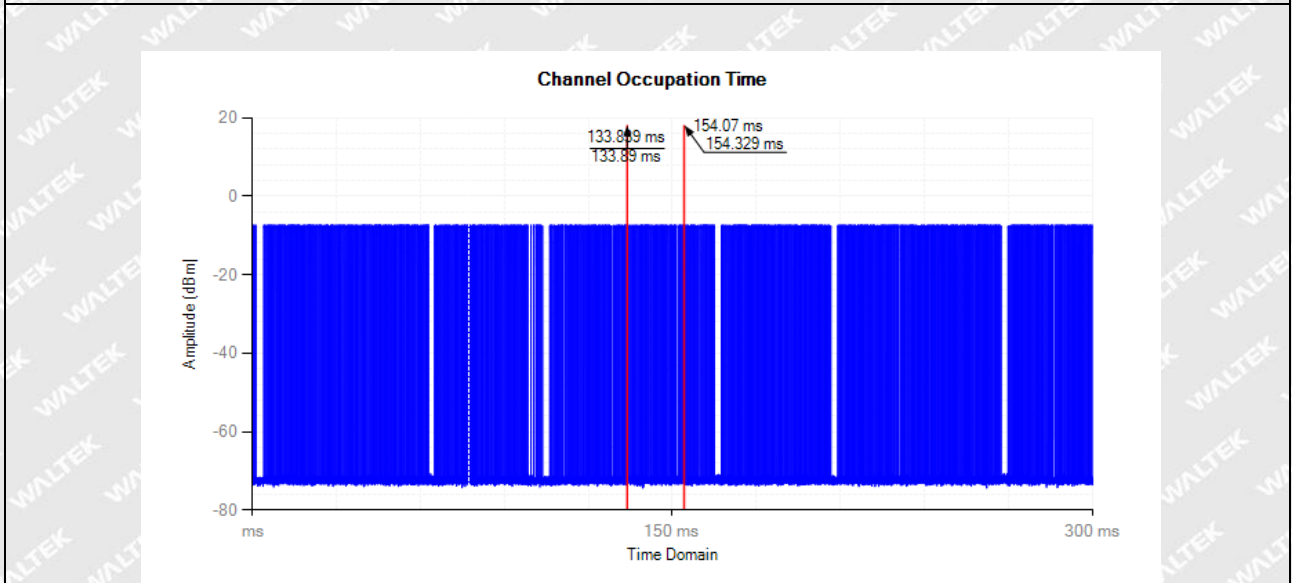
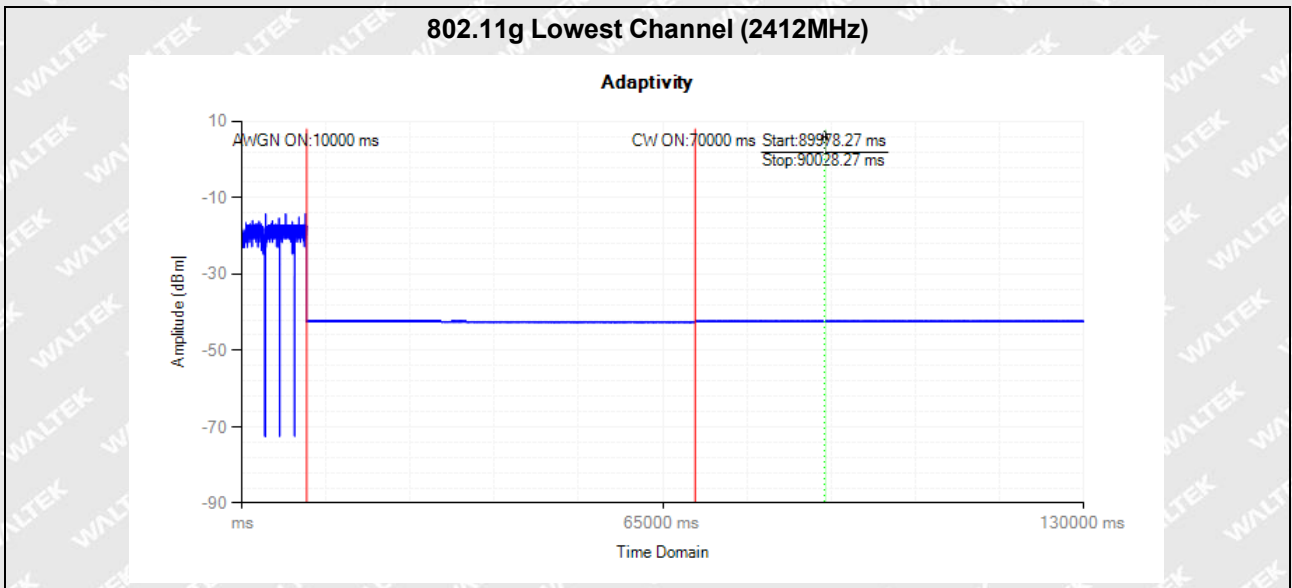

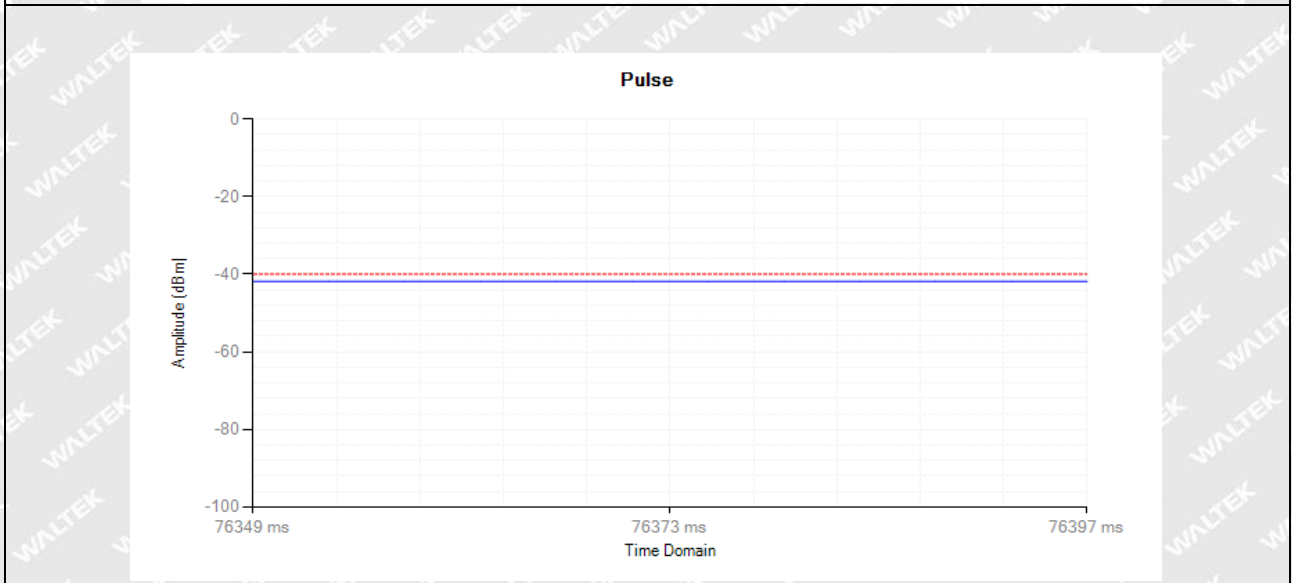
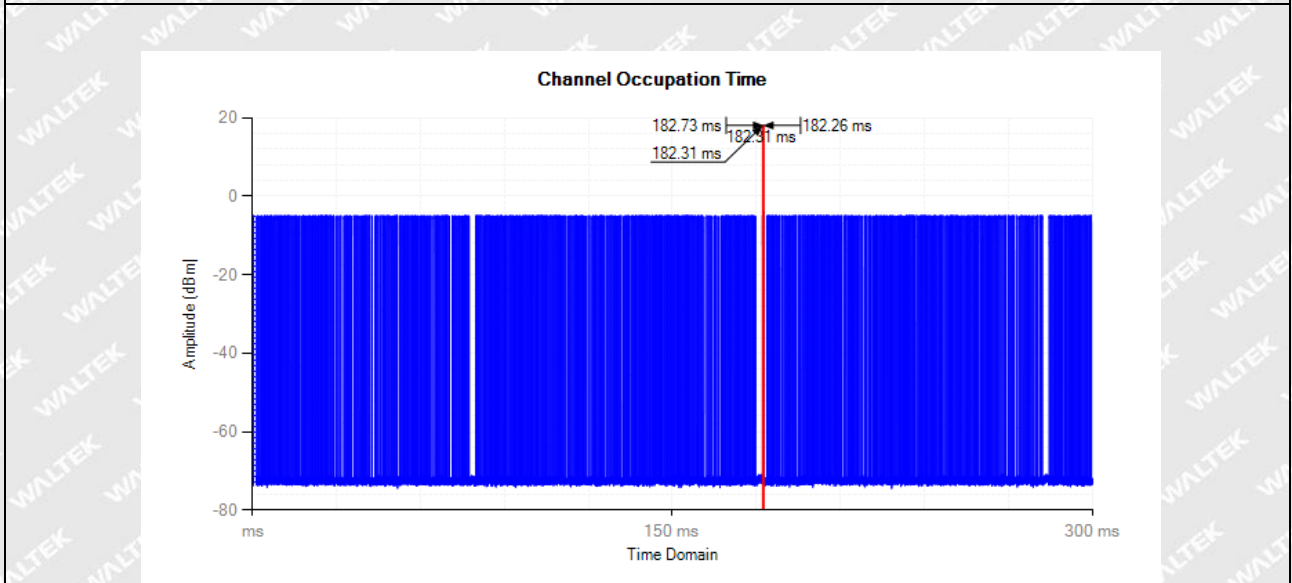
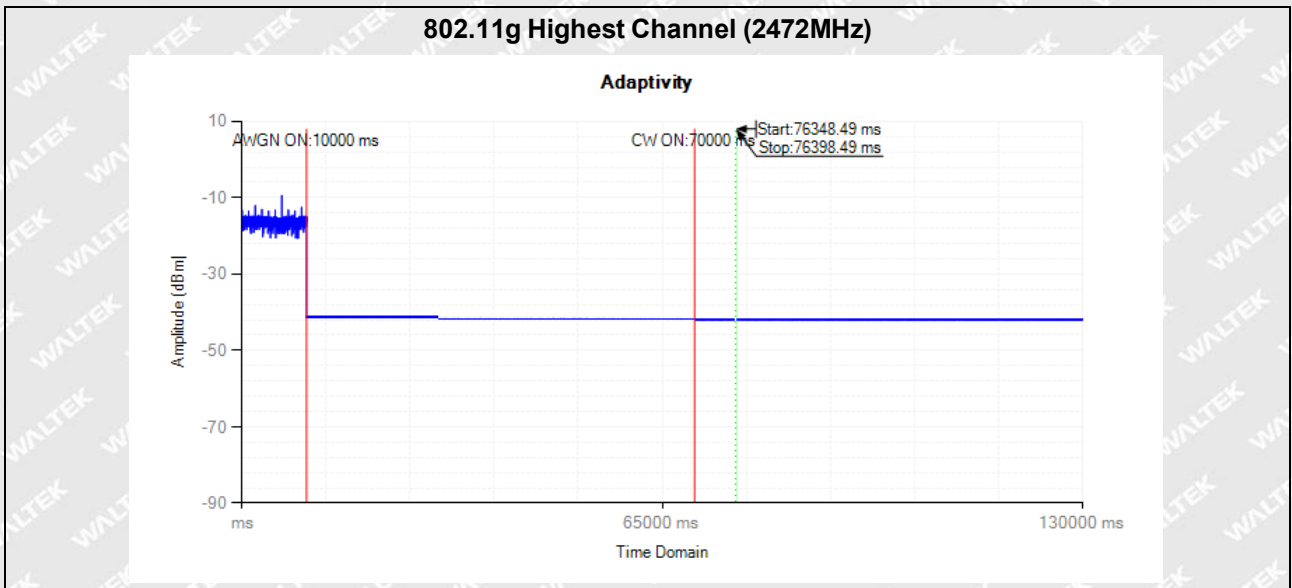



802.1n-HT20 Lowest Channel (2412MHz)

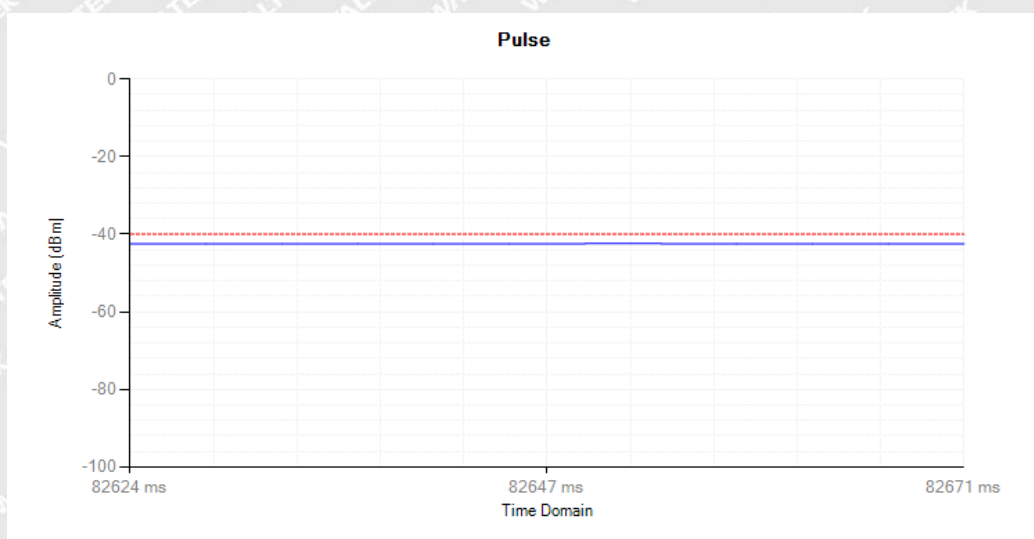
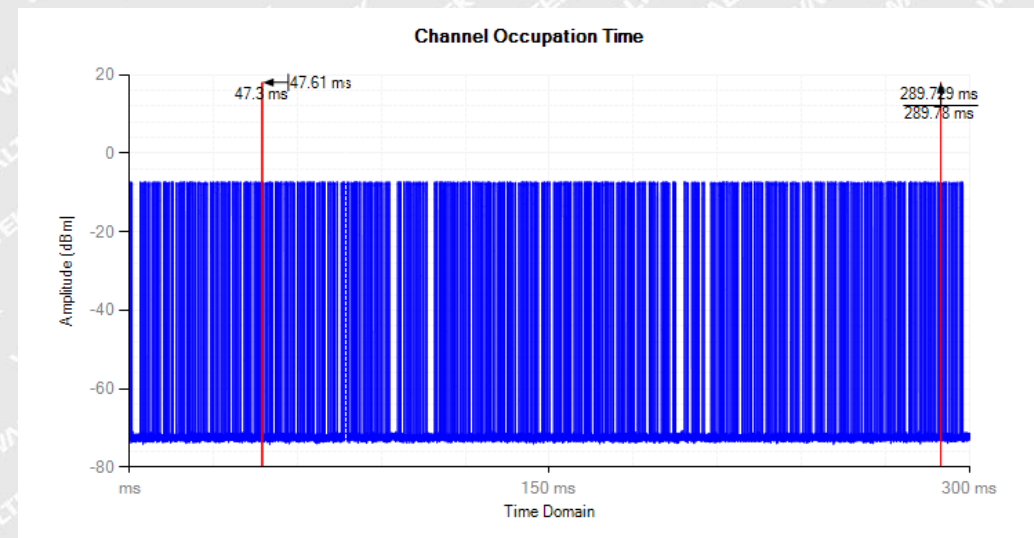
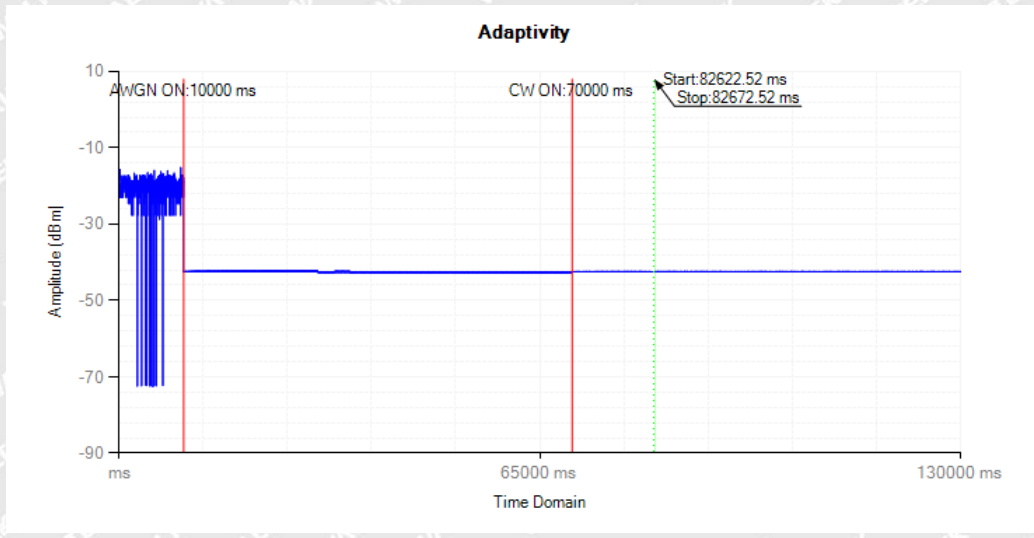



802.11n-HT20 highest Channel (2472MHz)

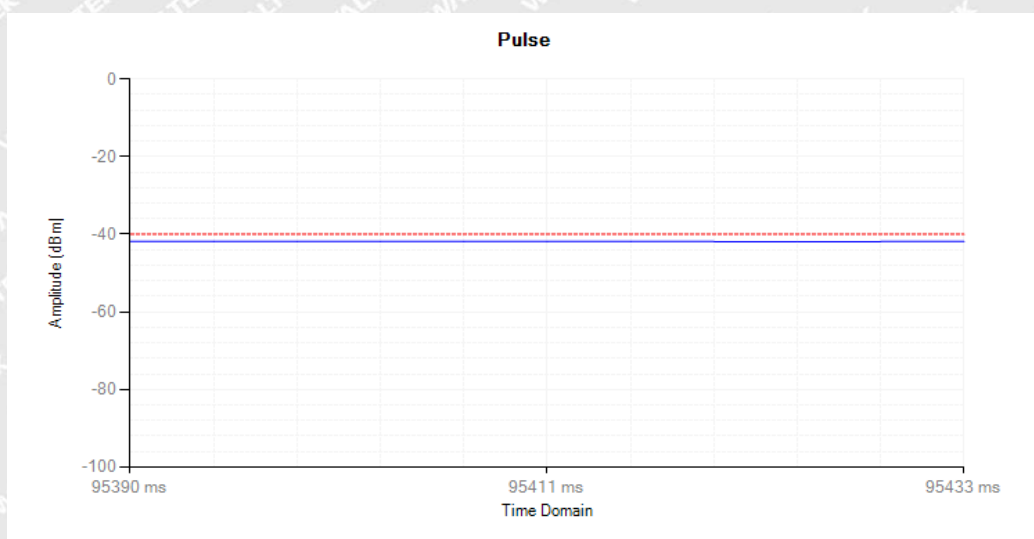
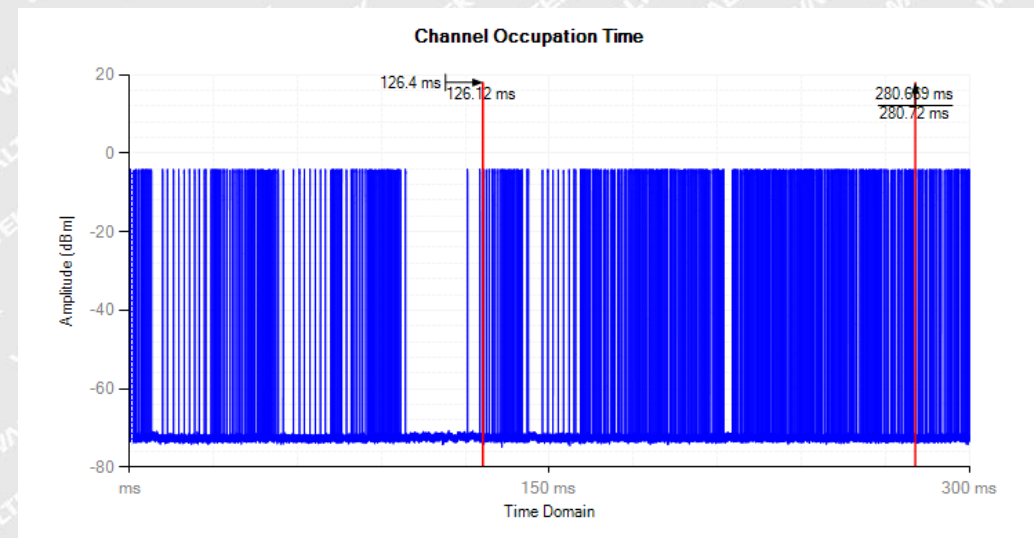
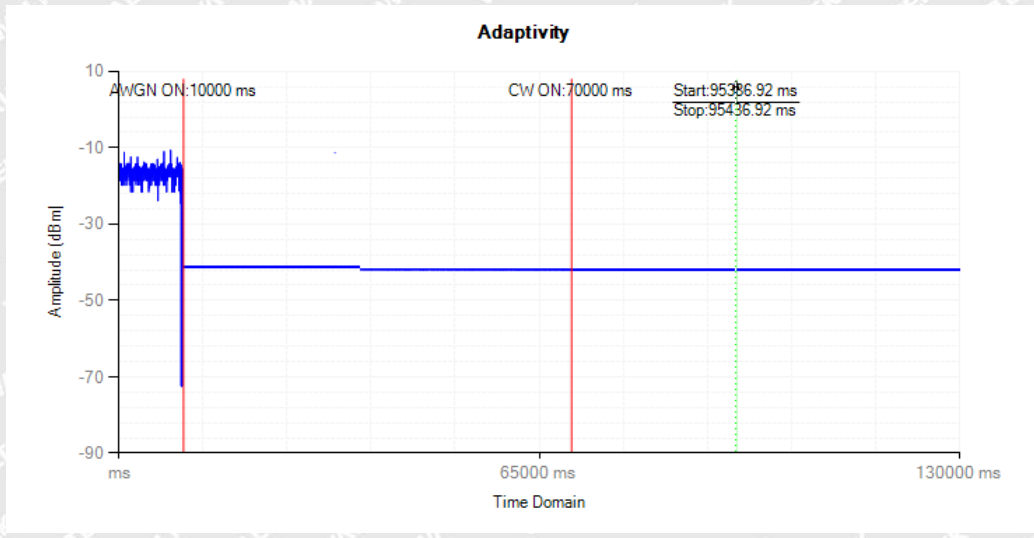



6. Occupied Channel Bandwidth

6.1 Standard Application

According to section 4.3.2.7.3, the Occupied Channel Bandwidth shall fall completely within the band given in clause 1. In addition, for non-adaptive systems using wide band modulations other than FHSS and with e.i.r.p greater than 10 dBm, the occupied channel bandwidth shall be less than 20MHz.

6.2 Test procedure

According to the section 5.4.7.2.1, the measurement procedure shall be as follows:

Step 1:

Connect the UUT to the spectrum analyser and use the following settings:

- Centre Frequency: The centre frequency of the channel under test
- Resolution BW: ~ 1 % of the span without going below 1 %
- Video BW: 3 × RBW
- Frequency Span: 2 × Occupied Channel Bandwidth
- Detector Mode: RMS
- Trace Mode: Max Hold

Step 2:

Wait until the trace is completed.

Find the peak value of the trace and place the analyser marker on this peak.

Step 3:

Use the 99 % bandwidth function of the spectrum analyser to measure the Occupied Channel Bandwidth of the UUT. This value shall be recorded.

6.3 Summary of Test Results/Plots



Mode	Channel	Measured Frequency (MHz)		Limit (MHz)	Result
		Low	High		
802.11b	Low	2405.27	2418.79	2400.00~2483.50	Pass
	High	2464.97	2478.60		
802.11g	Low	2403.35	2420.47	2400.00~2483.50	Pass
	High	2463.14	2480.33		
802.11n HT20	Low	2402.96	2421.01	2400.00~2483.50	Pass
	High	2462.89	2480.97		

WALTEK

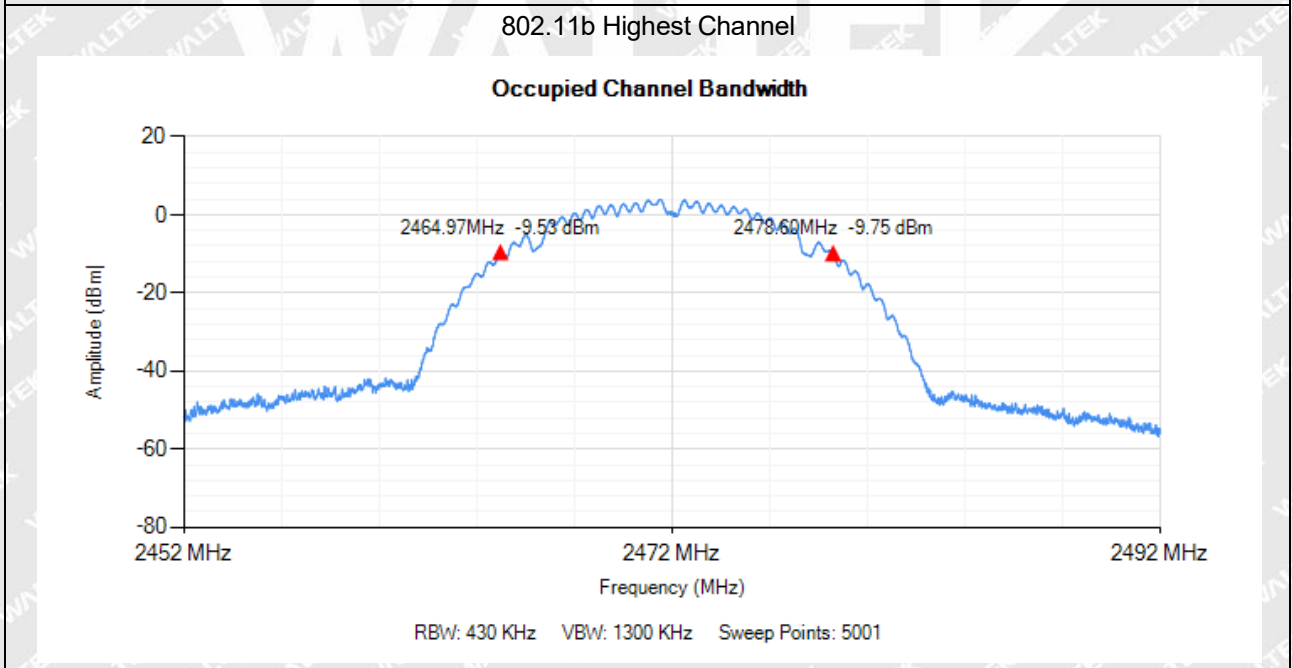
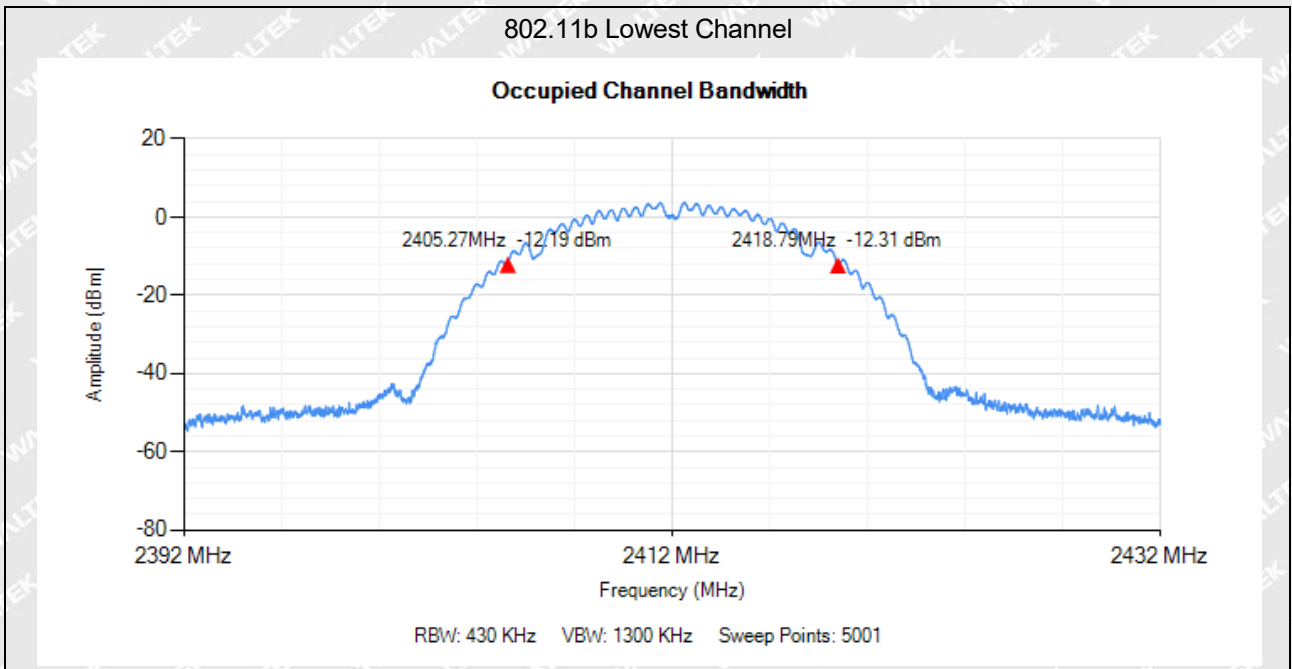

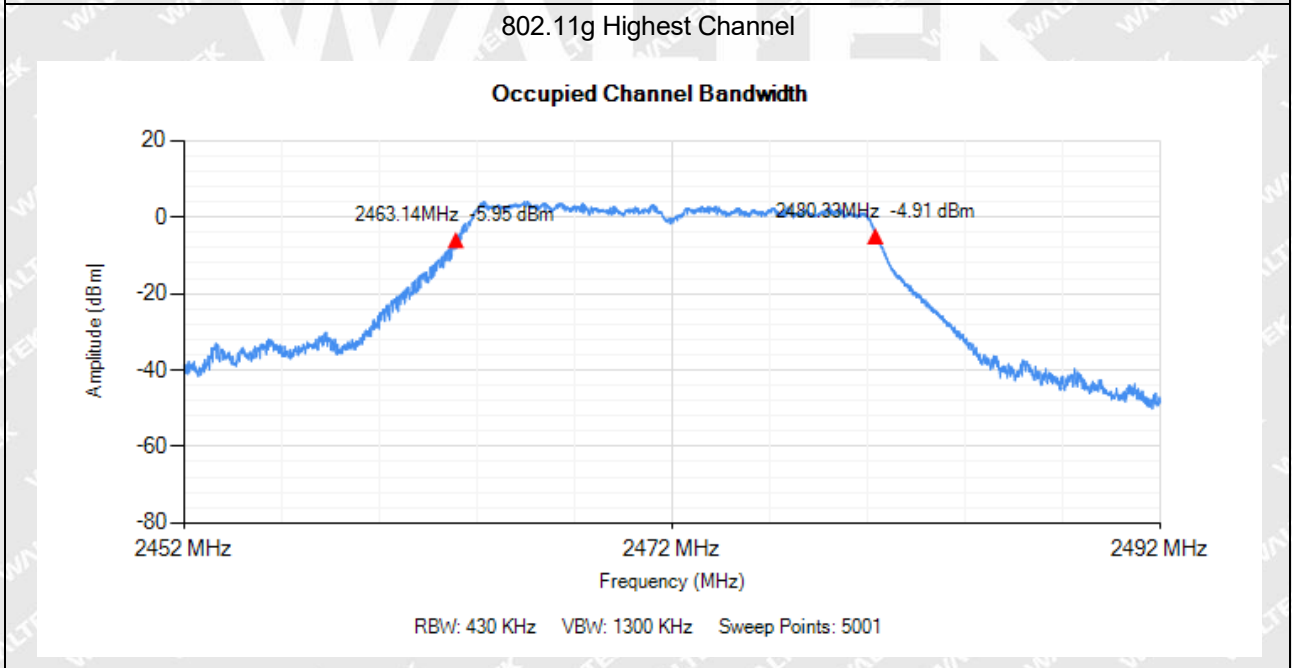
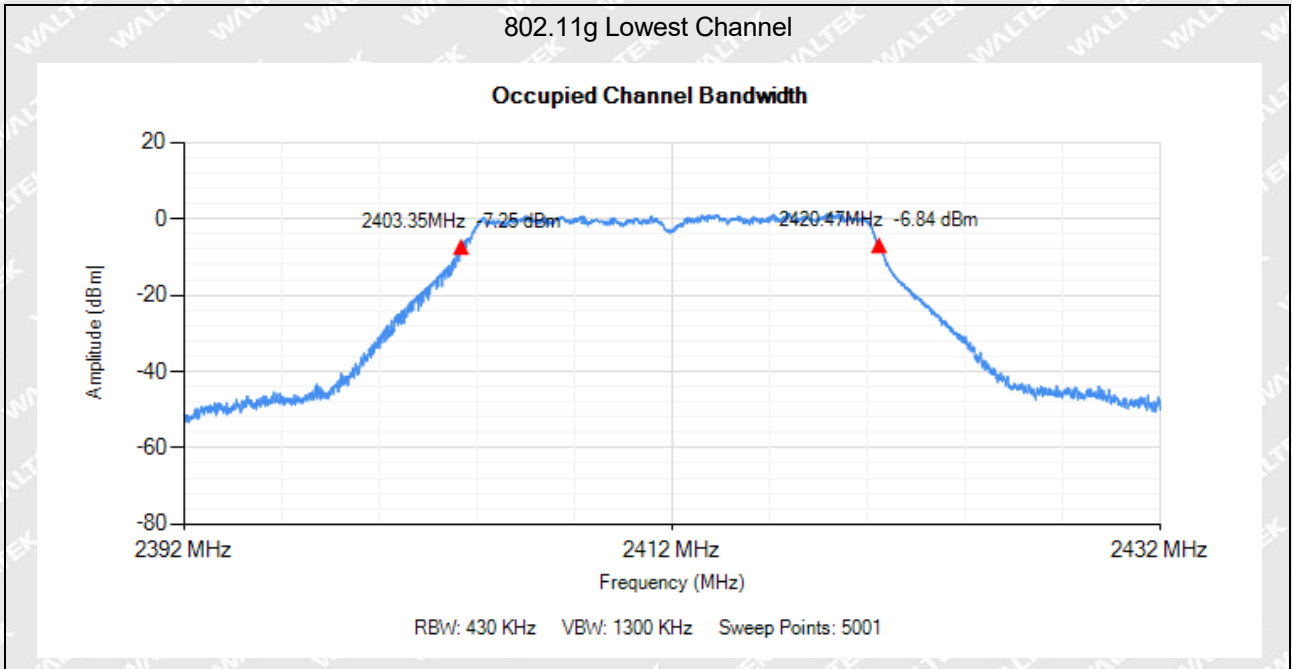



802.11n HT20 Lowest Channel

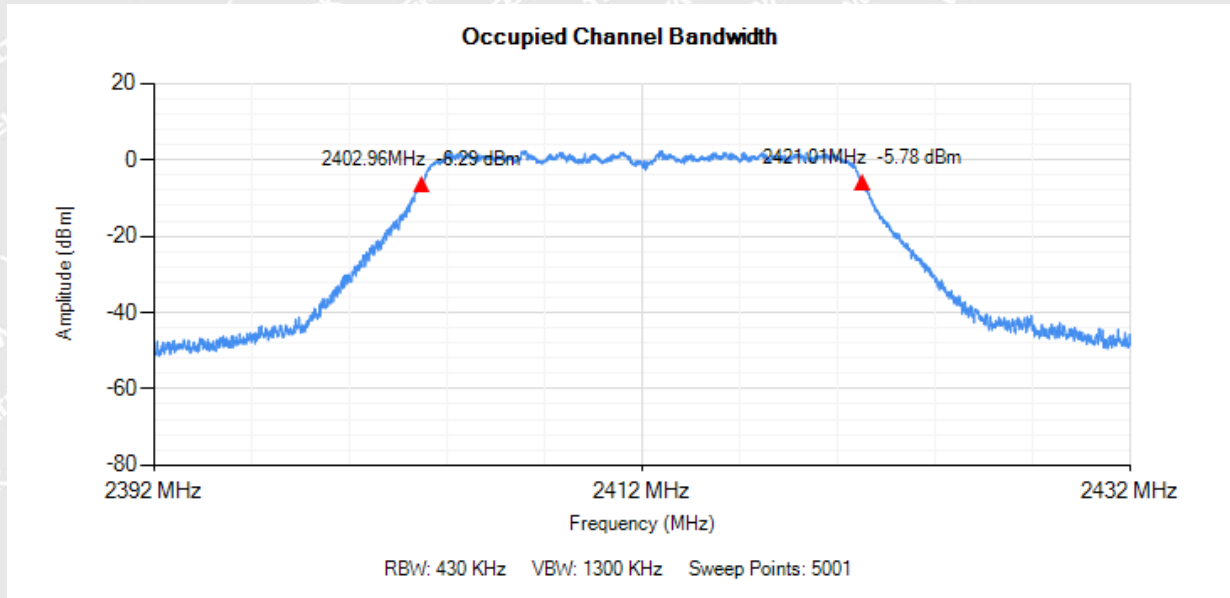

802.11n HT20 Highest Channel

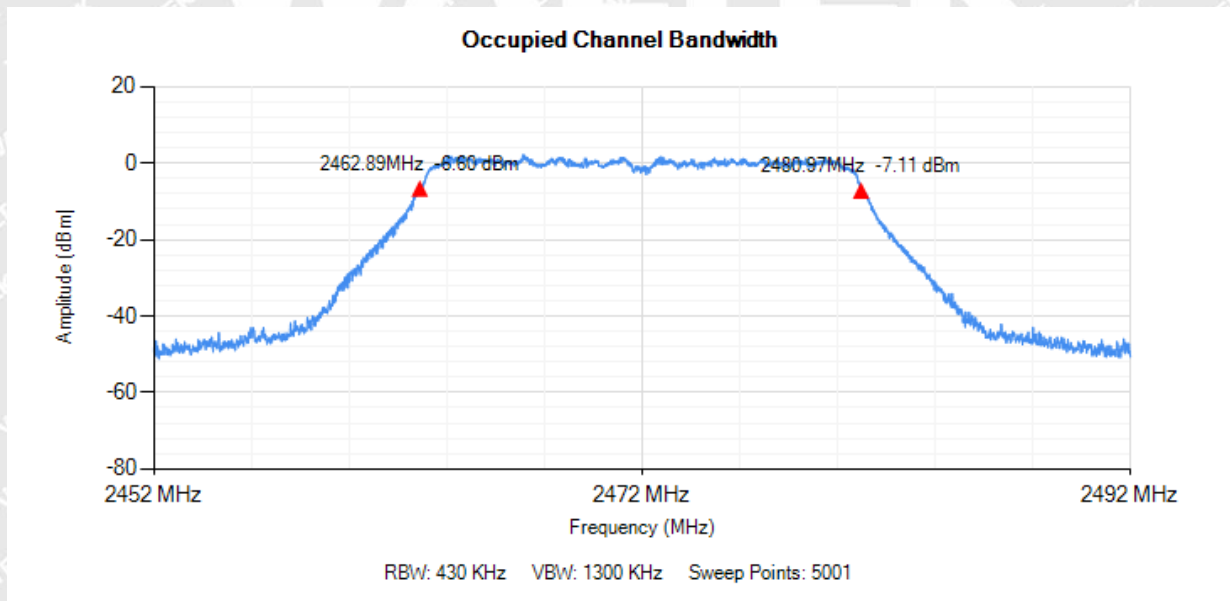



7. Transmitter Unwanted Emissions in the Out-of-band Domain

7.1 Standard Application

According to section 4.3.2.8.3, the transmitter unwanted emissions in the out-of-band domain but outside the allocated band, shall not exceed the values provided by the mask in figure 3.

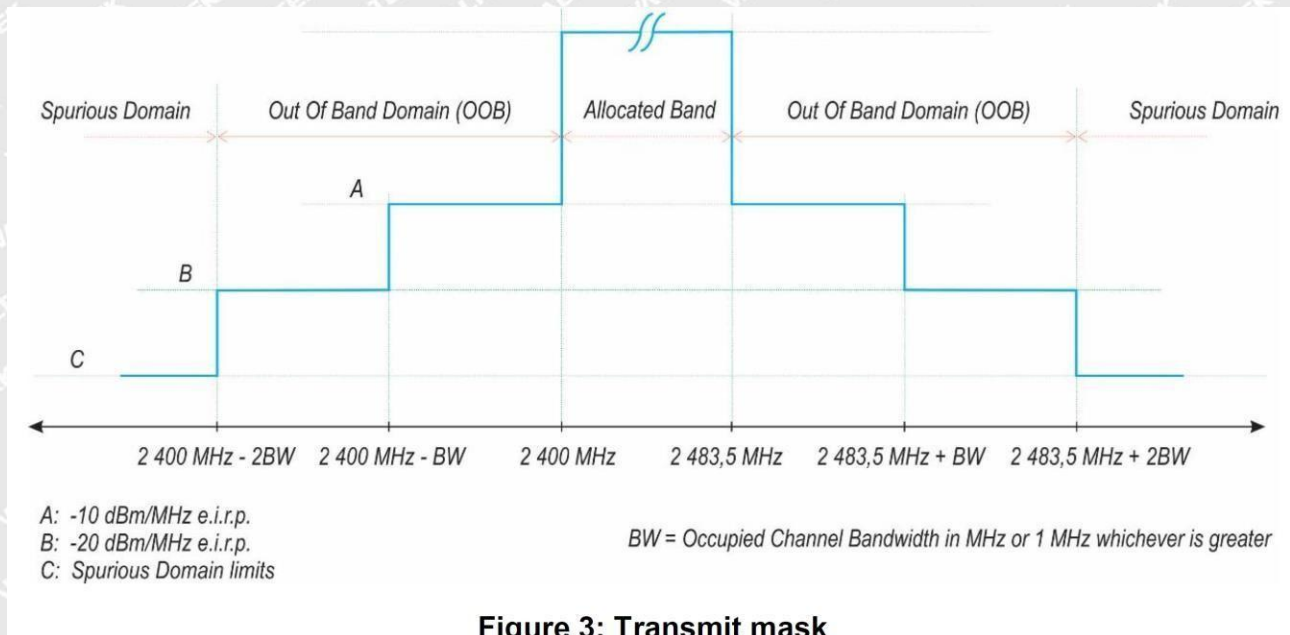

Figure 3: Transmit mask

7.2 Test procedure

According to the section 5.4.8.2.1, the measurement procedure shall be as follows:

The Out-of-band emissions within the different horizontal segments of the mask provided in figures 1 and 3 shall be measured using the steps below. This method assumes the spectrum analyser is equipped with the Time Domain Power option.

Step 1:

- Connect the UUT to the spectrum analyser and use the following settings:
 - Centre Frequency: 2 484 MHz
 - Span: 0 Hz
 - Resolution BW: 1 MHz
 - Filter mode: Channel filter
 - Video BW: 3 MHz
 - Detector Mode: RMS
 - Trace Mode: Clear / Write
 - Sweep Mode: Continuous
 - Sweep Points: 5 000
 - Trigger Mode: Video trigger



Reference No.: WTX24X01018378W001

- Sweep Time: Suitable to capture one transmission burst

Step 2: (segment 2483.5MHz to 2483.5MHz + BW)

- Adjust the trigger level to select the transmissions with the highest power level.
- For frequency hopping equipment operating in a normal hopping mode, the different hops will result in signal bursts with different power levels. In this case the burst with the highest power level shall be selected.
- Set a window (start and stop lines) to match with the start and end of the burst and in which the RMS power shall be measured using the Time Domain Power function.
- Select RMS power to be measured within the selected window and note the result which is the RMS power within this 1 MHz segment (2483.5MHz to 2484.5MHz). Compare this value with the applicable limit provided by the mask.
- Increase the centre frequency in steps of 1MHz and repeat this measurement for every 1MHz segment within the range 2483.5 MHz to 2483.5MHz + BW. The centre frequency of the last 1MHz segment shall be set to 2483.5MHz + BW – 0.5MHz (which means this may partly overlap with the previous 1MHz segment).

Step 3: (segment 2 483.5MHz + BW to 2 483.5MHz + 2BW)

- Change the centre frequency of the analyser to 2484MHz + BW and perform the measurement for the first 1MHz segment within range 2483.5MHz + BW to 2483.5MHz + 2BW. Increase the centre frequency in 1MHz steps and repeat the measurements to cover this whole range. The centre frequency of the last 1 MHz segment shall be set to 2483.5MHz + 2 BW – 0.5MHz.

Step 4: (segment 2400MHz - BW to 2400MHz)

- Change the centre frequency of the analyser to 2 399.5MHz and perform the measurement for the first 1 MHz segment within range 2400MHz - BW to 2400MHz Reduce the centre frequency in 1MHz steps and repeat the measurements to cover this whole range. The centre frequency of the last 1 MHz segment shall be set to 2400MHz - 2BW + 0.5MHz.

Step 5: (segment 400 MHz - 2BW to 2 400MHz - BW)

- Change the centre frequency of the analyser to 2399.5MHz - BW and perform the measurement for the first 1MHz segment within range 2400MHz - 2BW to 2400MHz - BW. Reduce the centre frequency in 1MHz steps and repeat the measurements to cover this whole range. The centre frequency of the last 1 MHz segment shall be set to 2400MHz - 2BW + 0.5MHz.

Step 6:

- In case of conducted measurements on equipment with a single transmit chain, the declared antenna assembly gain "G" in dBi shall be added to the results for each of the 1 MHz segments and compared with the limits provided by the mask given in figures 1 or 3. If more than one antenna assembly is intended for this power setting, the antenna with the highest gain shall be considered.

These measurements have to be performed at normal environmental conditions and shall be repeated at the extremes of the operating temperature range.

RBW/VBW=1MHz/3MHz



7.3 Summary of Test Results/Plots.

Test CH.	Test Segment	Max. Emissions Reading (dBm)	Limit
	MHz	Normal	dBm
Test Mode: 802.11b			
Lowest	2400-BW to 2400	-44.56	-10
	2400-2BW to 2400-BW	-52.14	-20
Highest	2483.5 to 2483.5+BW	-43.77	-10
	2483.5+BW to 2483.5+2BW	-54.51	-20
Test Mode: 802.11g			
Lowest	2400-BW to 2400	-35.33	-10
	2400-2BW to 2400-BW	-52.81	-20
Highest	2483.5 to 2483.5+BW	-31.02	-10
	2483.5+BW to 2483.5+2BW	-52.75	-20
Test Mode: 802.11n-HT20			
Lowest	2400-BW to 2400	-33.78	-10
	2400-2BW to 2400-BW	-52.87	-20
Highest	2483.5 to 2483.5+BW	-31.11	-10
	2483.5+BW to 2483.5+2BW	-53.77	-20
Note 1: BW please refer to section 6.3			
Note 2: the data just list the worst cases			

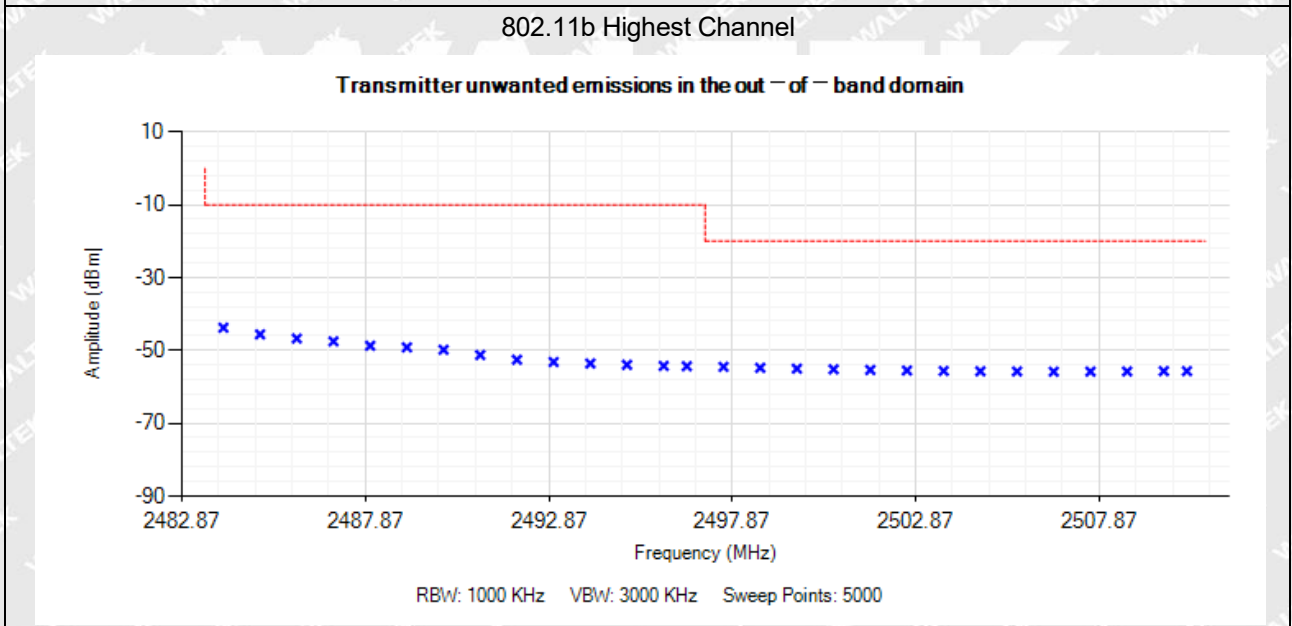
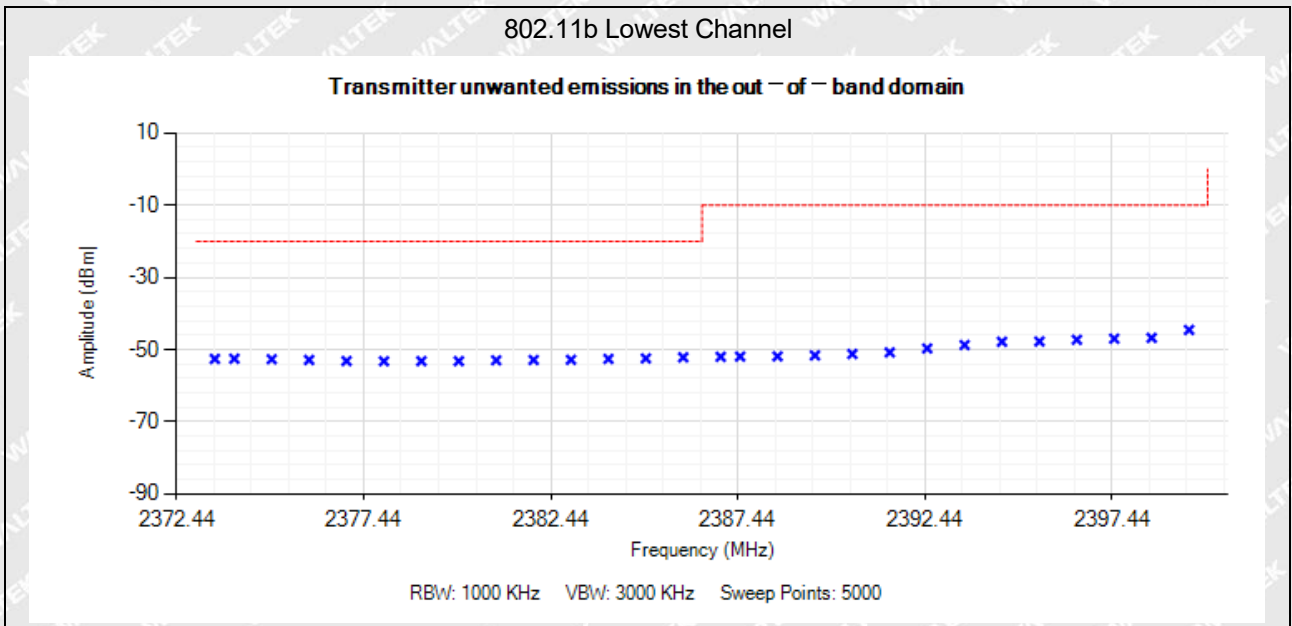

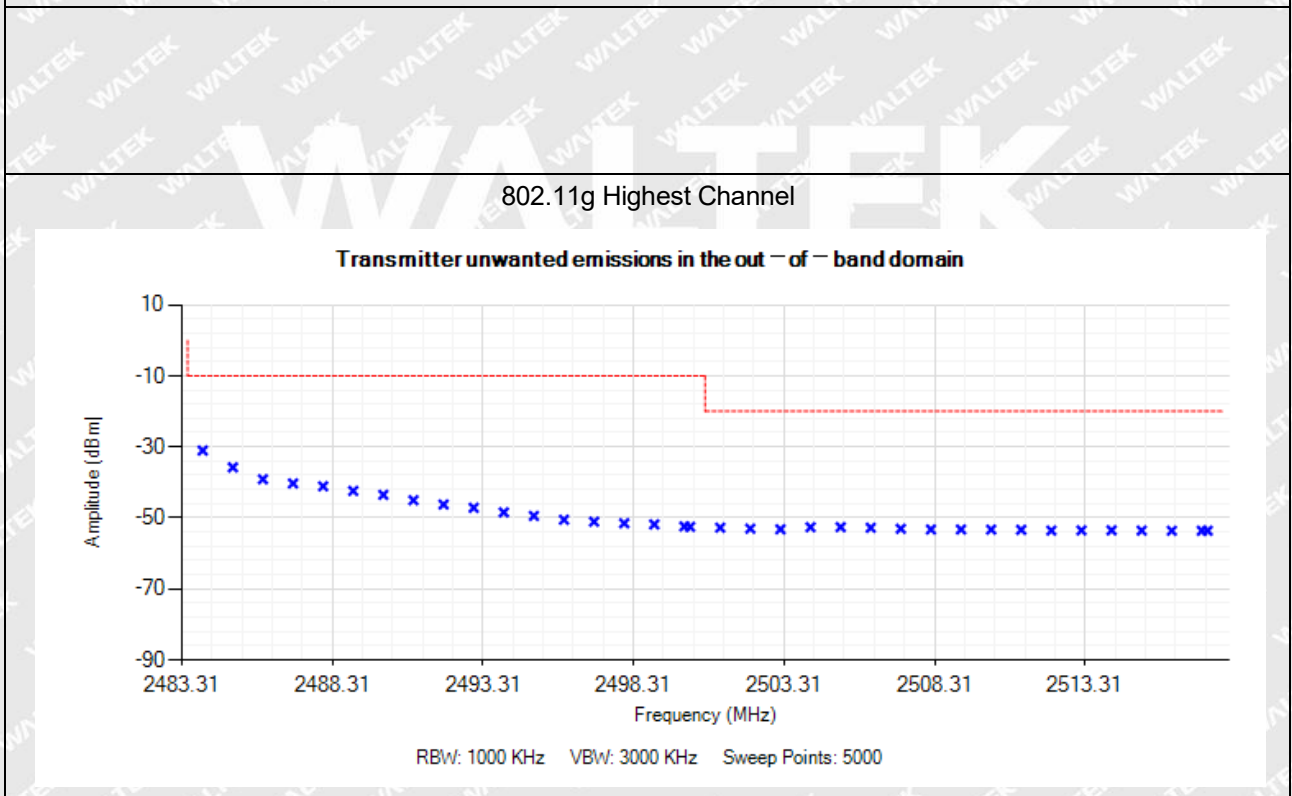
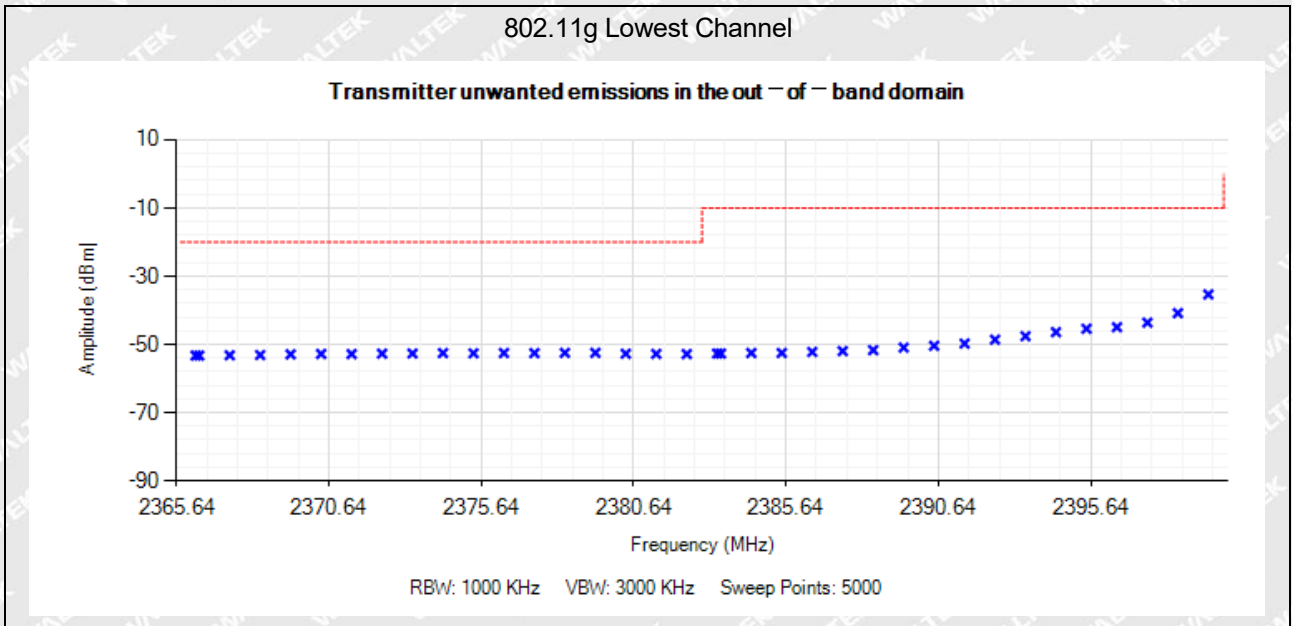

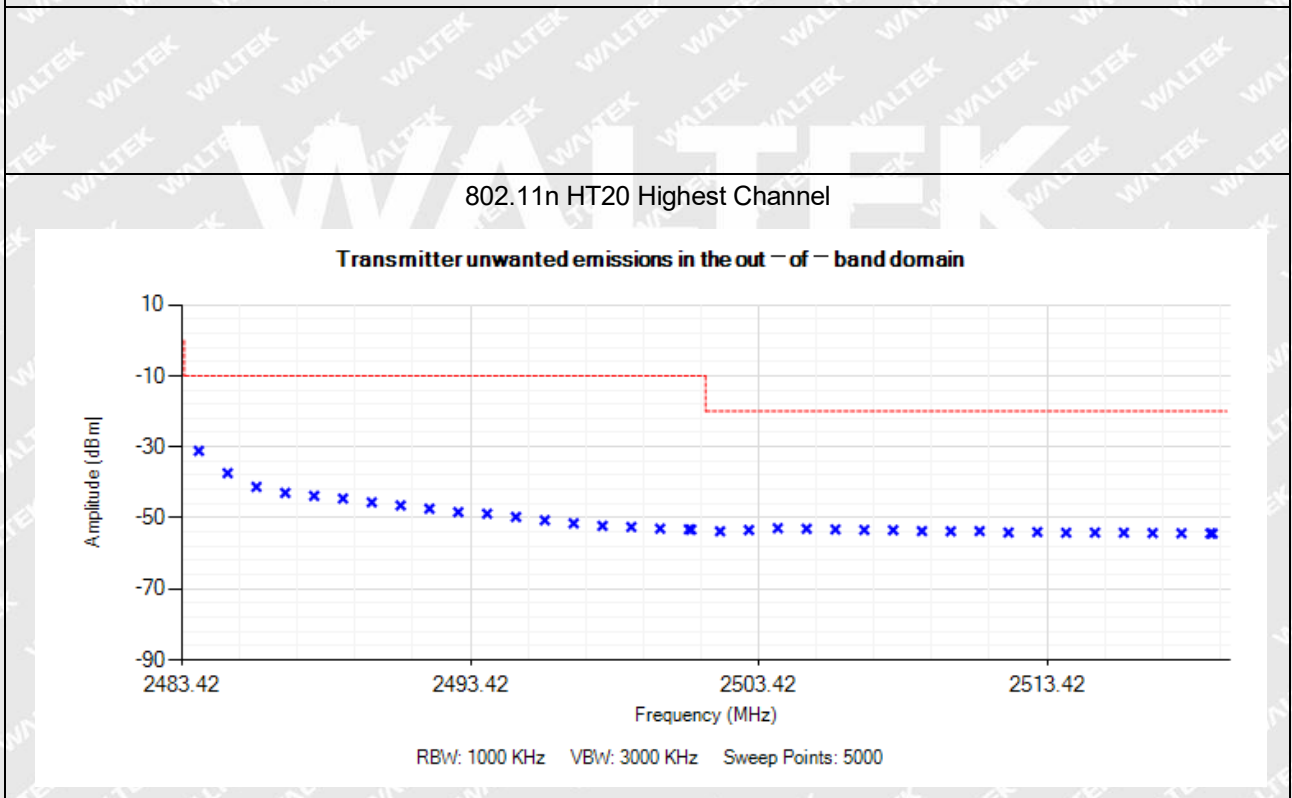
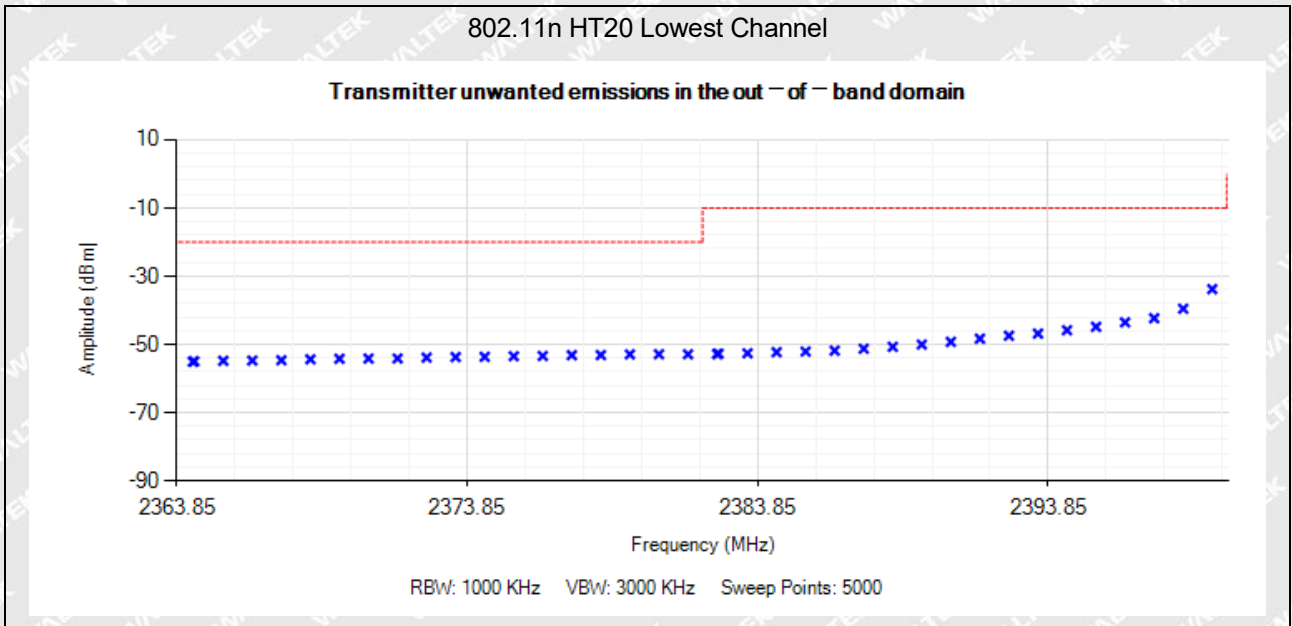



8. Transmitter Unwanted Emissions in the Spurious Domain

8.1 Standard Applicable

According to section 4.3.2.9.3, the transmitter unwanted emissions in the spurious domain shall not exceed the values given in the following table.

Transmitter limit for spurious emissions

Frequency range	Maximum power	Bandwidth
30MHz to 47MHz	-36dBm	100kHz
47MHz to 74MHz	-54dBm	100kHz
74MHz to 87.5MHz	-36dBm	100kHz
87.5MHz to 118MHz	-54dBm	100kHz
118MHz to 174MHz	-36dBm	100kHz
174MHz to 230MHz	-54dBm	100kHz
230MHz to 470MHz	-36dBm	100kHz
470MHz to 694MHz	-54dBm	100kHz
694MHz to 1GHz	-36dBm	100kHz
1GHz to 12.75GHz	-30dBm	1MHz

8.2 Test Procedure

The device under test has an integral antenna and the radiated measurement shall apply to the device, using the method of measurement as described in the EN300328 section 5.4.9.2.

RBW=100kHz VBW=300kHz 30MHz-1GHz

RBW=1MHz VBW=3MHz 1GHz-12.75GHz

8.3 Summary of Test Results/Plots

According to the data, the EUT complied with the EN 300328 standards, and had the worst cases:



➤ Radiated Spurious Emission From 30MHz To 1GHz

802.11b			
Test Channel:	Lowest channel	Polarity:	Horizontal

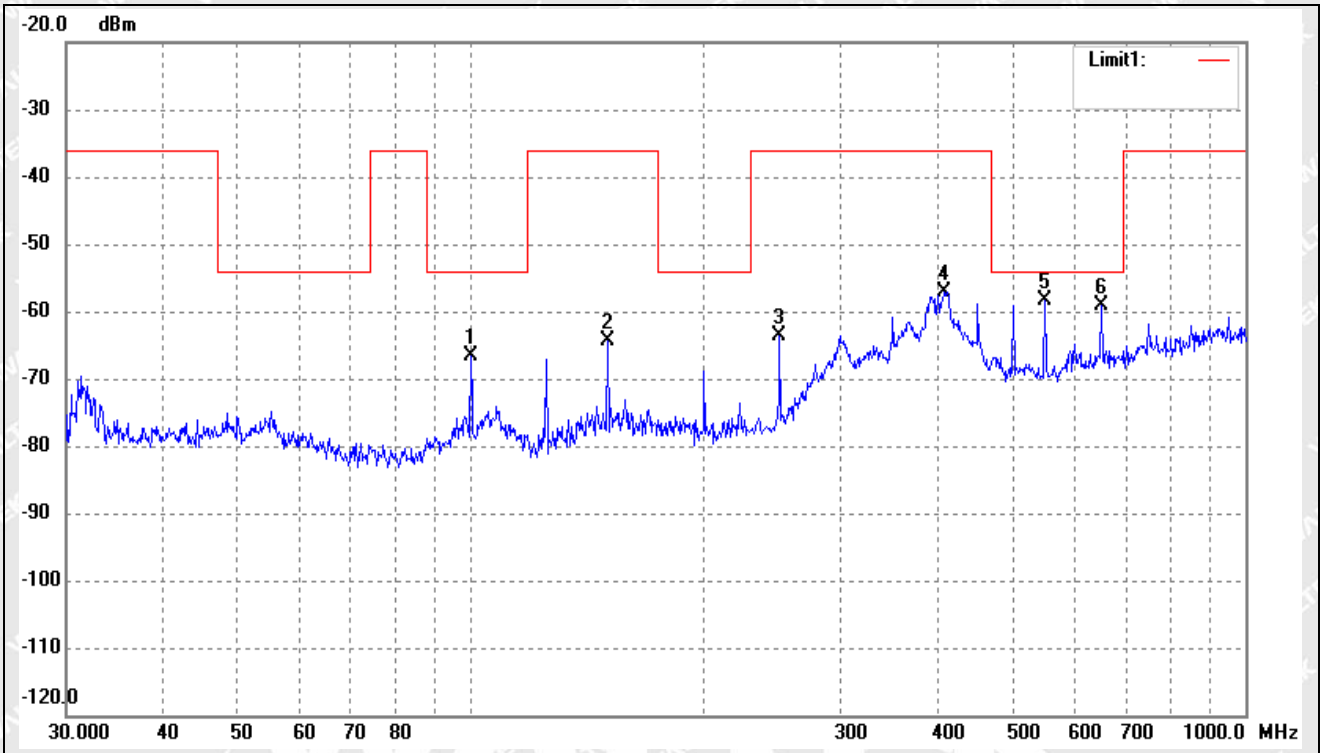

No.	Frequency (MHz)	Reading (dBm)	Correct (dB)	Result (dBm)	Limit (dBm)	Margin (dB)	Remark
1	99.8777	-69.78	3.07	-66.71	-54.00	-12.71	ERP
2	150.0108	-64.28	-0.05	-64.33	-36.00	-28.33	ERP
3	250.3012	-68.77	5.22	-63.55	-36.00	-27.55	ERP
4	407.5145	-66.43	9.30	-57.13	-36.00	-21.13	ERP
5	550.9480	-69.80	11.54	-58.26	-54.00	-4.26	ERP
6	651.9417	-72.86	13.67	-59.19	-54.00	-5.19	ERP



802.11b			
Test Channel:	Lowest channel	Polarity:	Vertical

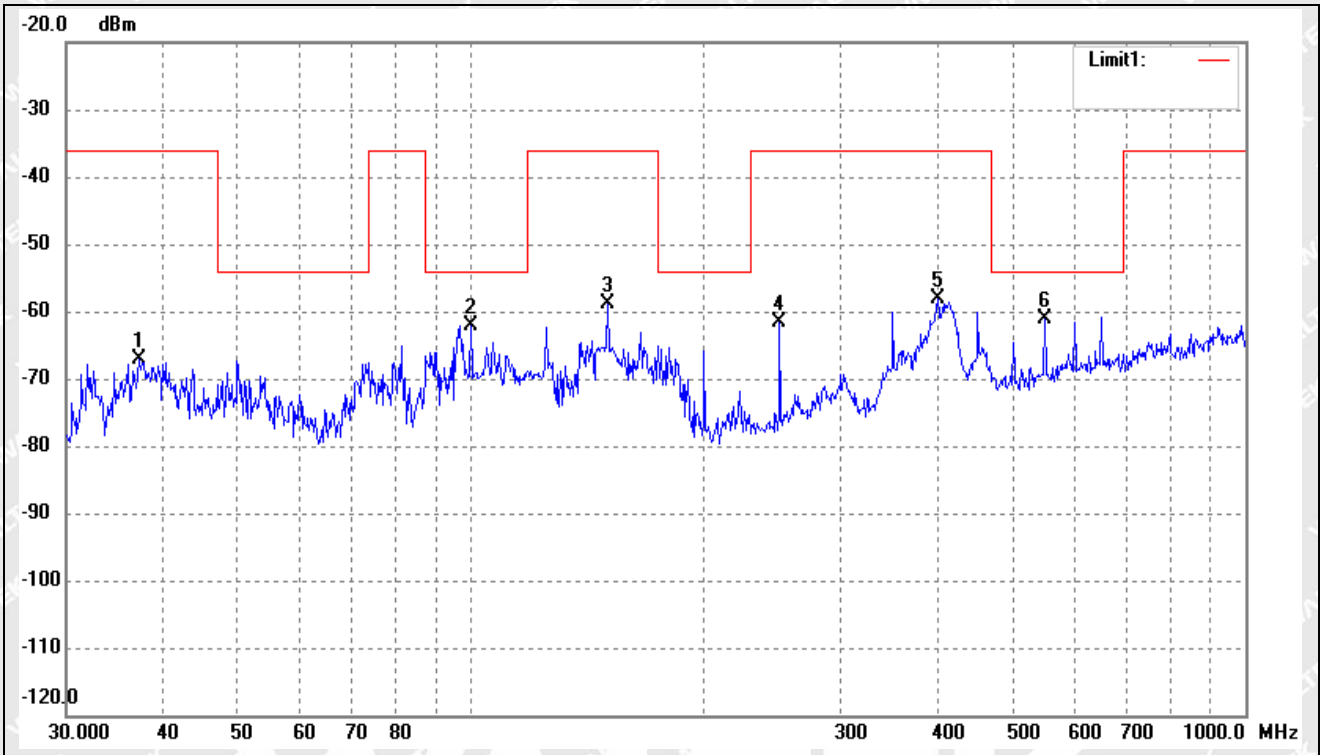

No.	Frequency (MHz)	Reading (dBm)	Correct (dB)	Result (dBm)	Limit (dBm)	Margin (dB)	Remark
1	37.2855	-69.03	2.01	-67.02	-36.00	-31.02	ERP
2	99.8777	-65.11	3.07	-62.04	-54.00	-8.04	ERP
3	150.0108	-58.93	-0.05	-58.98	-36.00	-22.98	ERP
4	250.3012	-66.87	5.22	-61.65	-36.00	-25.65	ERP
5	400.4319	-67.36	9.12	-58.24	-36.00	-22.24	ERP
6	550.9480	-72.76	11.54	-61.22	-54.00	-7.22	ERP



802.11b

Test Channel:

Highest channel

Polarity:

Horizontal

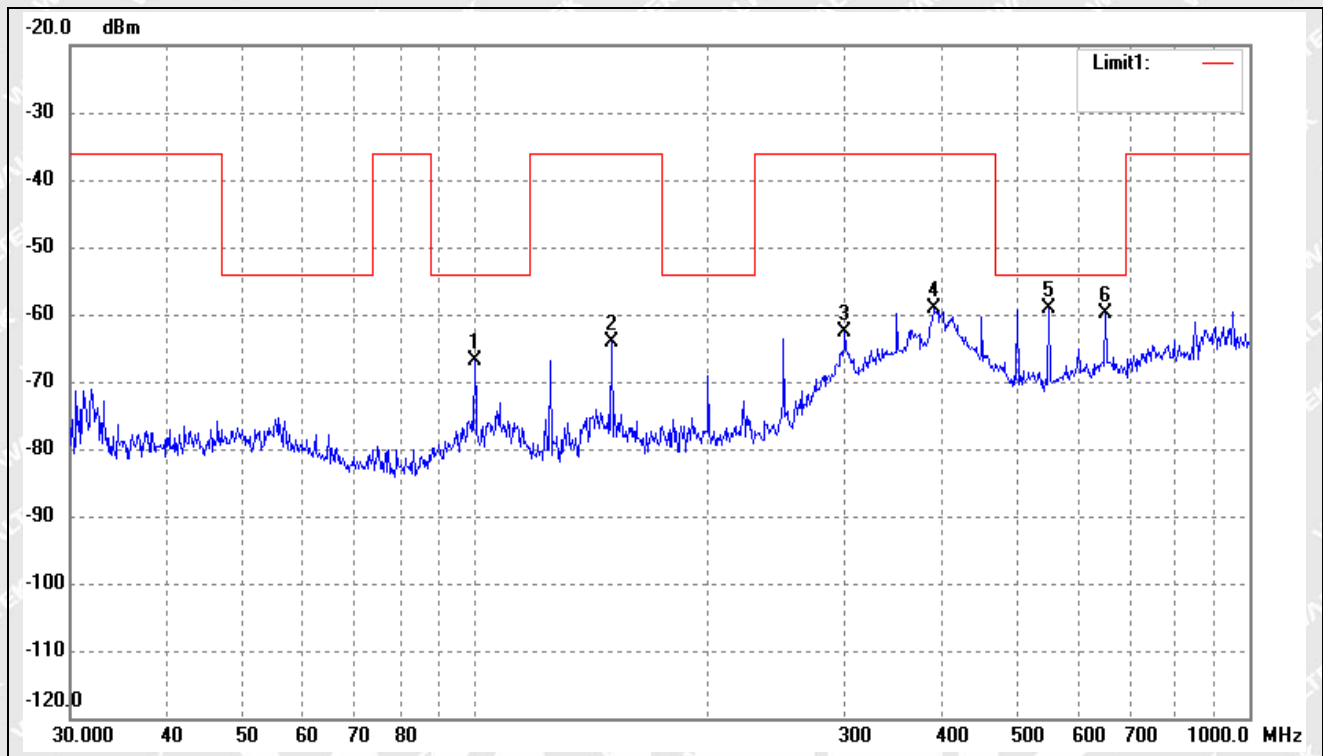

No.	Frequency (MHz)	Reading (dBm)	Correct dB	Result (dBm)	Limit (dBm)	Margin (dB)	Remark
1	99.8777	-69.85	3.07	-66.78	-54.00	-12.78	ERP
2	150.0108	-64.01	-0.05	-64.06	-36.00	-28.06	ERP
3	300.3673	-69.45	6.90	-62.55	-36.00	-26.55	ERP
4	392.0951	-67.96	8.89	-59.07	-36.00	-23.07	ERP
5	550.9480	-70.70	11.54	-59.16	-54.00	-5.16	ERP
6	651.9417	-73.61	13.67	-59.94	-54.00	-5.94	ERP



802.11b			
Test Channel:	Highest channel	Polarity:	Vertical

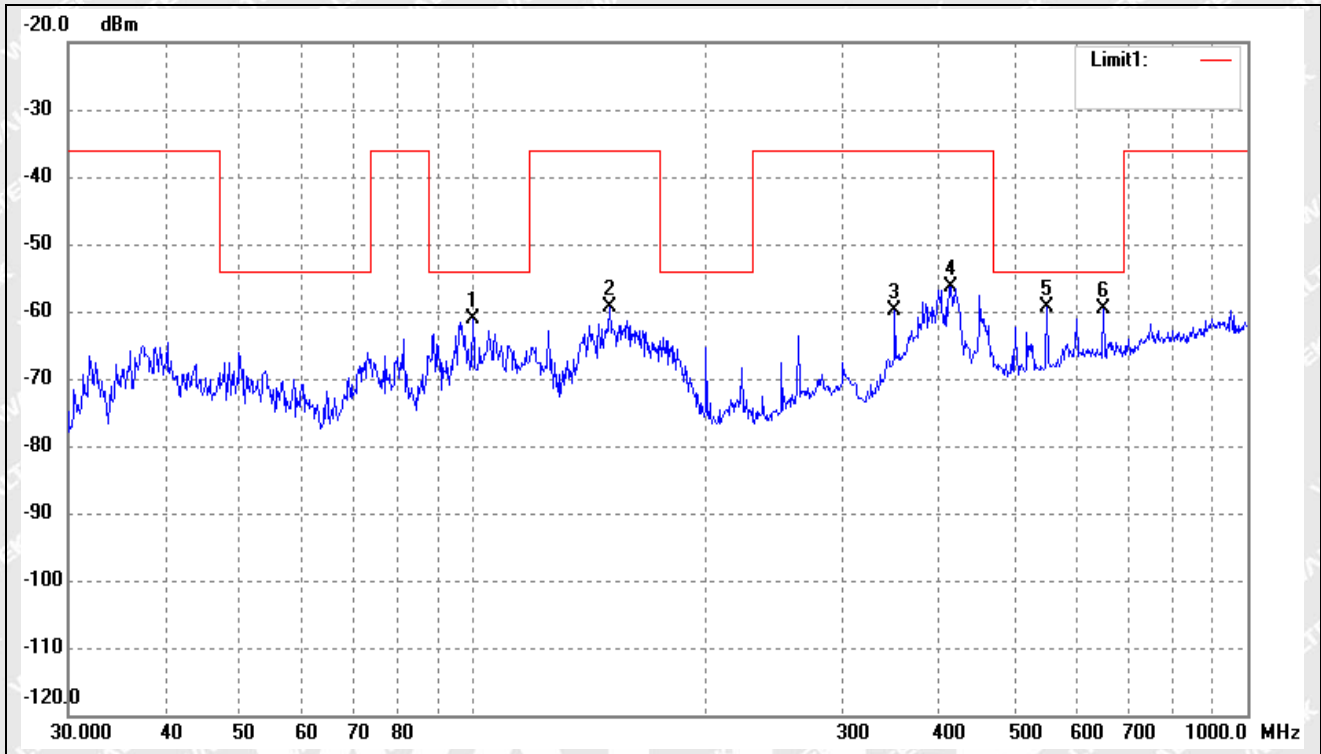

No.	Frequency (MHz)	Reading (dBm)	Correct (dB)	Result (dBm)	Limit (dBm)	Margin (dB)	Remark
1	99.8777	-64.11	3.07	-61.04	-54.00	-7.04	ERP
2	150.0108	-59.29	-0.05	-59.34	-36.00	-23.34	ERP
3	350.4768	-68.17	8.24	-59.93	-36.00	-23.93	ERP
4	414.7223	-65.75	9.41	-56.34	-36.00	-20.34	ERP
5	550.9480	-70.97	11.54	-59.43	-54.00	-5.43	ERP
6	651.9417	-73.21	13.67	-59.54	-54.00	-5.54	ERP

Note1: Pre-scan 802.11b, 802.11g, 802.11n(HT20) mode, and found the 802.11b mode which it is worse case, so only show the test data for worse case.



Reference No.: WTX24X01018378W001

➤ Radiated Spurious Emission Above 1GHz

Frequency (MHz)	Reading (dBm)	Correct dB	Result (dBm)	Limit (dBm)	Margin (dB)	Polar H/V
802.11b Lowest Channel						
4824.0	-51.68	7.92	-43.76	-30	-13.76	H
7236.0	-56.38	13.64	-42.74	-30	-12.74	H
4824.0	-52.91	7.92	-44.99	-30	-14.99	V
7236.0	-56.63	13.97	-42.66	-30	-12.66	V
802.11b Highest Channel						
4944.0	-52.16	8.27	-43.89	-30	-13.89	H
7416.0	-55.79	13.73	-42.06	-30	-12.06	H
4944.0	-49.76	8.27	-41.49	-30	-11.49	V
7416.0	-58.60	13.73	-44.87	-30	-14.87	V

Note 1: Testing is carried out with frequency rang 30MHz to 12.75GHz, which above 3th Harmonics are attenuated more than 20dB below the permissible limits or the field strength is too small to be measured.

Note 2: this EUT was tested in 3 orthogonal positions and the worst case position data was reported.

Note3: Pre-scan 802.11b, 802.11g, 802.11n(HT20) mode, and found the 802.11b mode which it is worse case, so only show the test data for worse case.





Reference No.: WTX24X01018378W001

➤ Conducted Transmitter Spurious Emission:

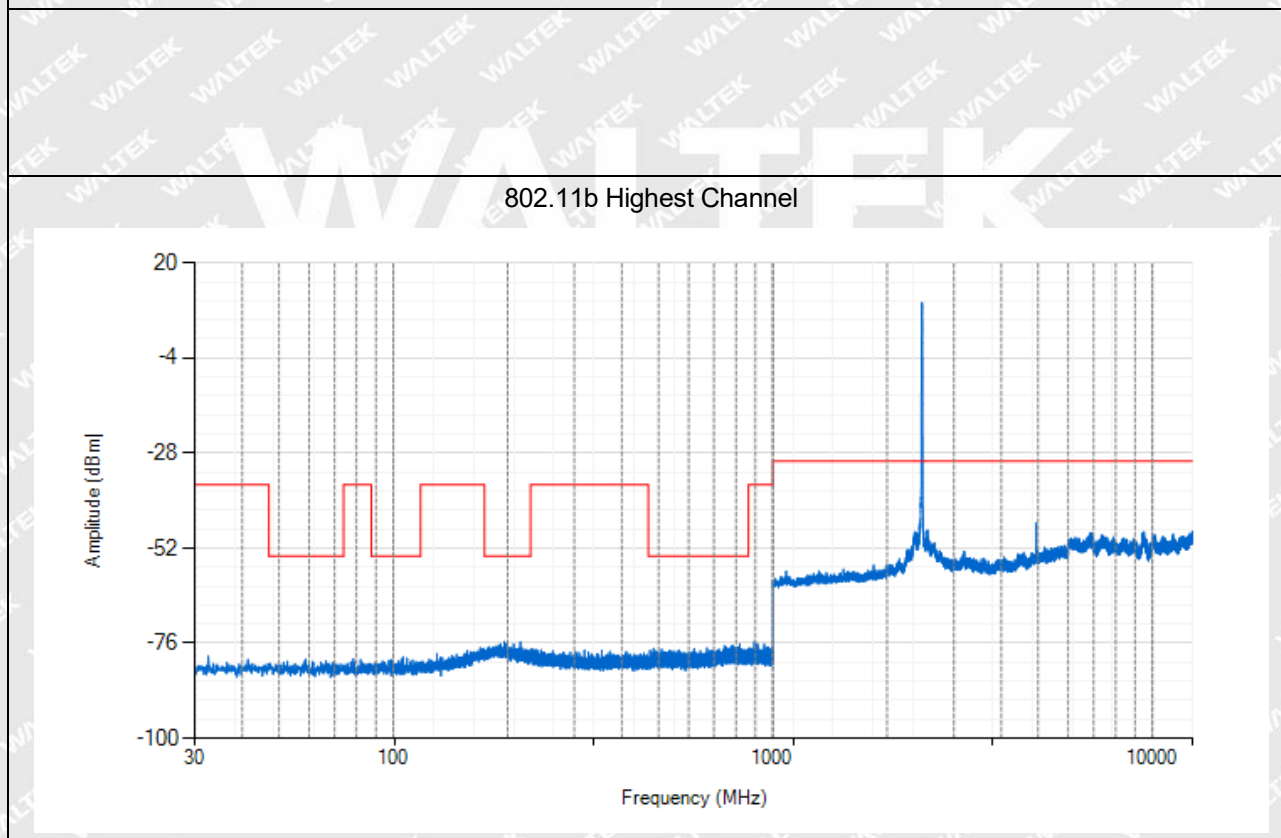
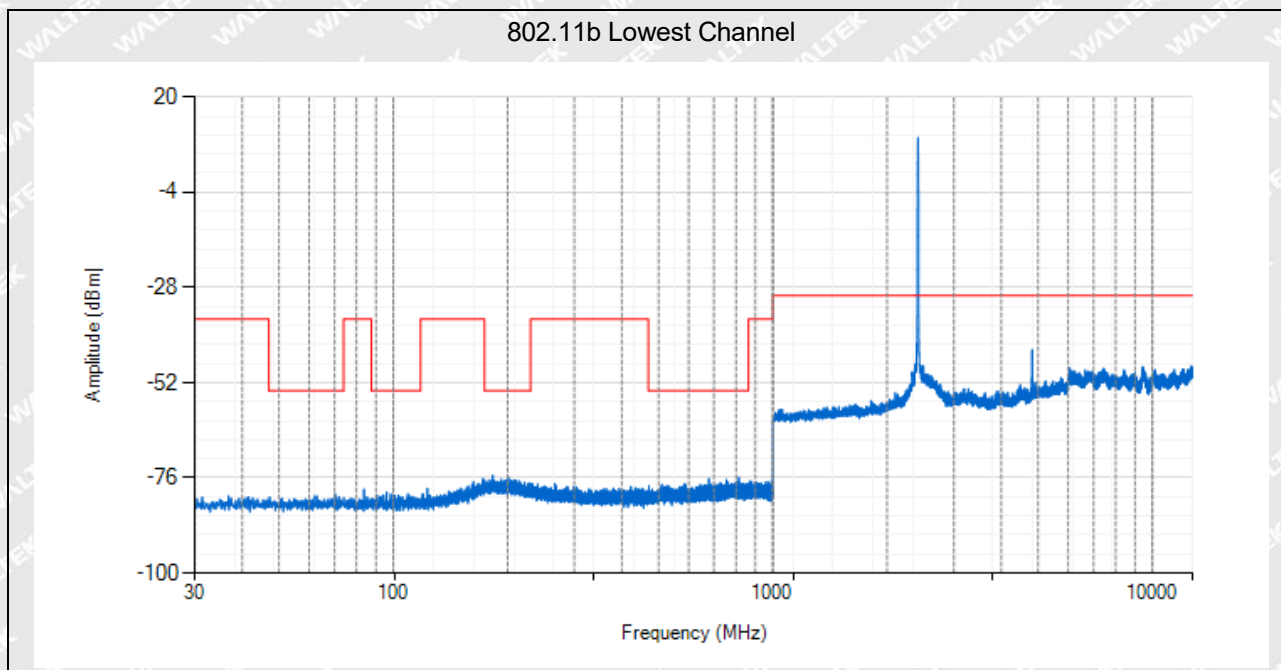

Note 1: Testing is carried out with frequency rang 30MHz to 12.75GHz, which emissions are too small are not list above.

Note2: Pre-scan 802.11b, 802.11g, 802.11n(HT20) mode, and found the 802.11b mode which it is worse case, so only show the test data for worse case.

Waltek Testing Group (Shenzhen) Co., Ltd.

[Http://www.waltek.com.cn](http://www.waltek.com.cn)



9. Receiver Spurious Emissions

9.1 Standard Applicable

According to section 4.3.2.10.3, the spurious emissions of the receiver shall not exceed the values given in the following table.

Spurious emission limits for receivers

Frequency range	Maximum power	Bandwidth
30MHz to 1GHz	-57dBm	100kHz
1GHz to 12.75GHz	-47dBm	1MHz

9.2 Test Procedure

The device under test has an integral antenna and the radiated measurement shall apply to the device, using the method of measurement as described in the EN300328 section 5.4.10.2.

RBW=100kHz VBW=300kHz 30MHz-1GHz

RBW=1MHz VBW=3MHz 1GHz-12.75GHz

9.3 Summary of Test Results/Plots

According to the data, the EUT complied with the EN 300328 standards, and had the worst cases:



➤ Radiated Receiver Spurious Emission From 30MHz To 1GHz

802.11b			
Test Channel:	Lowest channel(worst case)	Polarity:	Horizontal

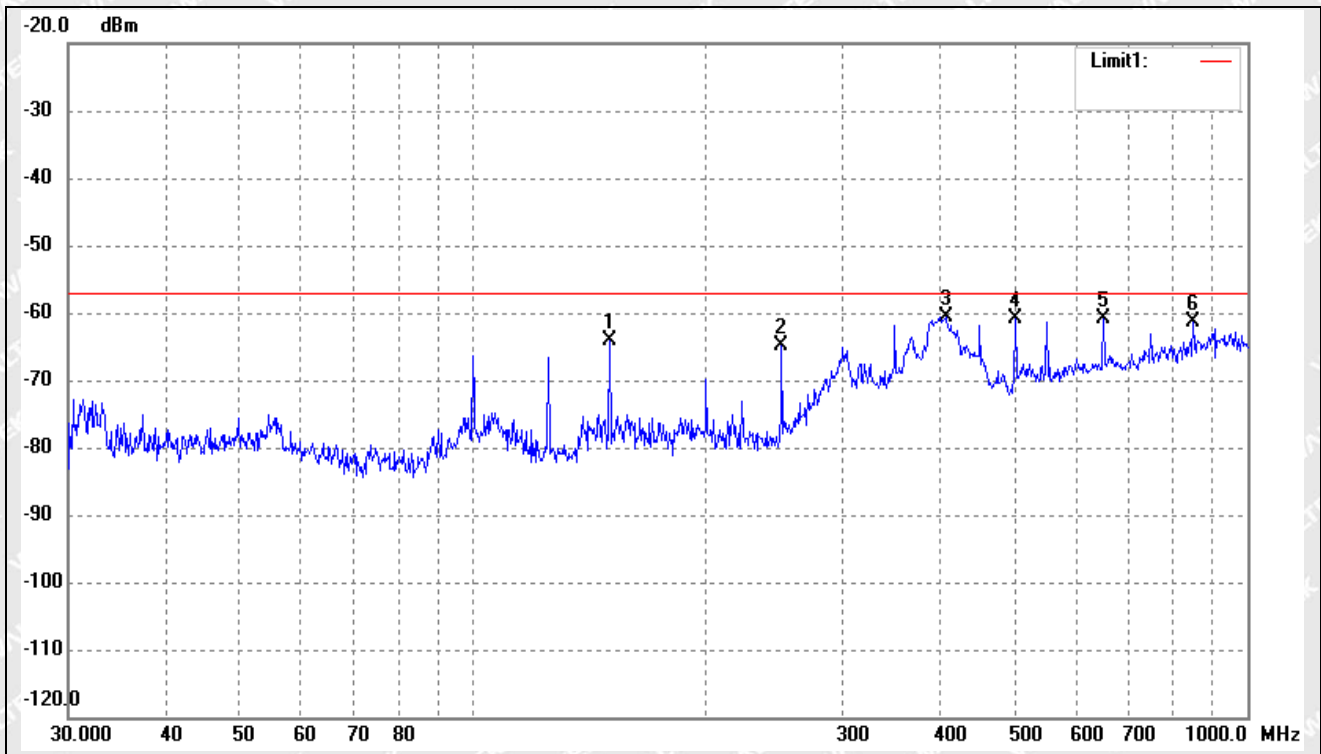

No.	Frequency (MHz)	Reading (dBm)	Correct (dB)	Result (dBm)	Limit (dBm)	Margin (dB)	Remark
1	150.0108	-64.13	-0.05	-64.18	-57.00	-7.18	ERP
2	250.3012	-70.07	5.22	-64.85	-57.00	-7.85	ERP
3	407.5145	-69.88	9.30	-60.58	-57.00	-3.58	ERP
4	501.1790	-71.53	10.62	-60.91	-57.00	-3.91	ERP
5	651.9417	-74.47	13.67	-60.80	-57.00	-3.80	ERP
6	851.0353	-77.42	16.13	-61.29	-57.00	-4.29	ERP



802.11b			
Test Channel:	Lowest channel(worst case)	Polarity:	Vertical

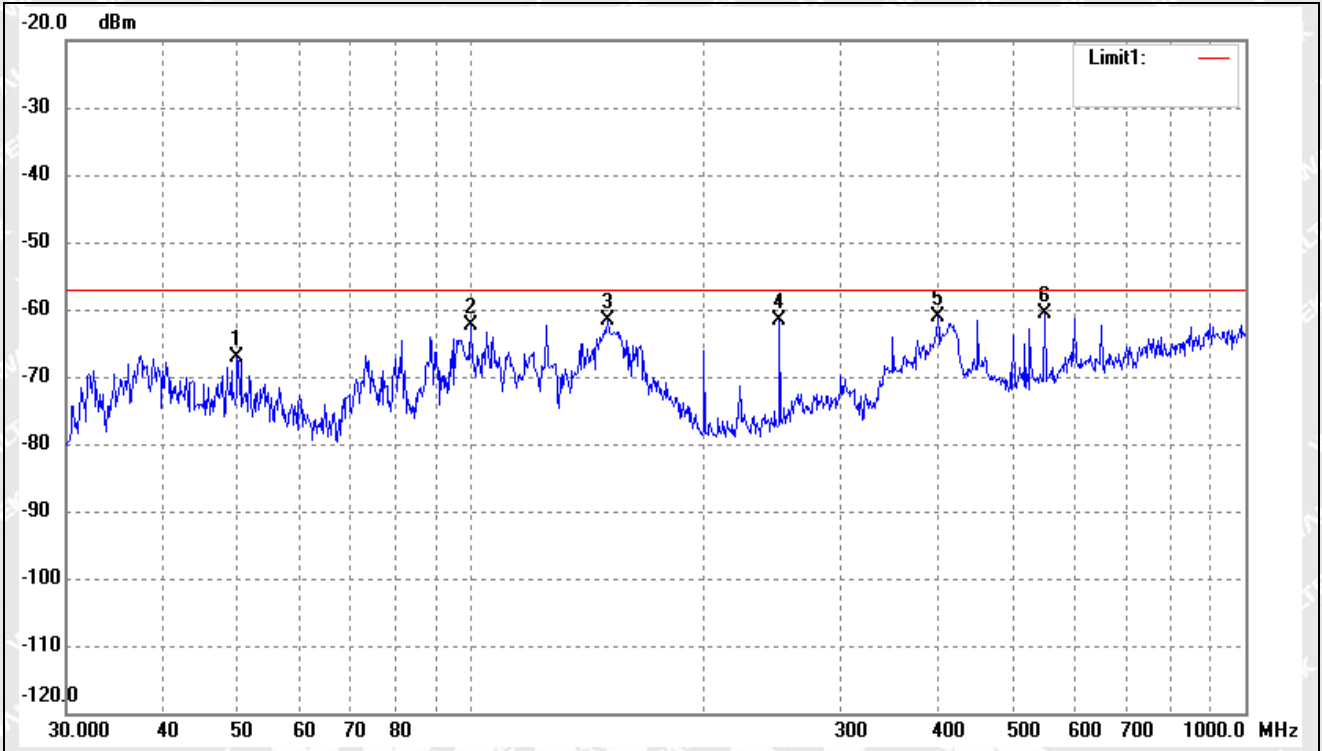

No.	Frequency (MHz)	Reading (dBm)	Correct (dB)	Result (dBm)	Limit (dBm)	Margin (dB)	Remark
1	49.8814	-70.97	3.85	-67.12	-57.00	-10.12	ERP
2	99.8777	-65.44	3.07	-62.37	-57.00	-5.37	ERP
3	150.0108	-61.58	-0.05	-61.63	-57.00	-4.63	ERP
4	250.3012	-66.85	5.22	-61.63	-57.00	-4.63	ERP
5	400.4319	-70.13	9.12	-61.01	-57.00	-4.01	ERP
6	550.9480	-72.12	11.54	-60.58	-57.00	-3.58	ERP



Reference No.: WTX24X01018378W001

➤ Radiated Receiver Spurious Emission Above 1GHz

Frequency (MHz)	Result (dBm)	Limit (dBm)	Margin (dB)	Polar H/V
1651.54	-60.03	-47	-13.03	H
3421.73	-55.76	-47	-8.76	H
4230.25	-60.61	-47	-13.61	V
5723.60	-52.70	-47	-5.70	V

Note1: Pre-scan 802.11b, 802.11g, 802.11n(HT20) mode, and found the 802.11b mode which it is worse case, so only show the test data for worse case.

WALTEK



➤ Conducted Receiver Spurious Emission

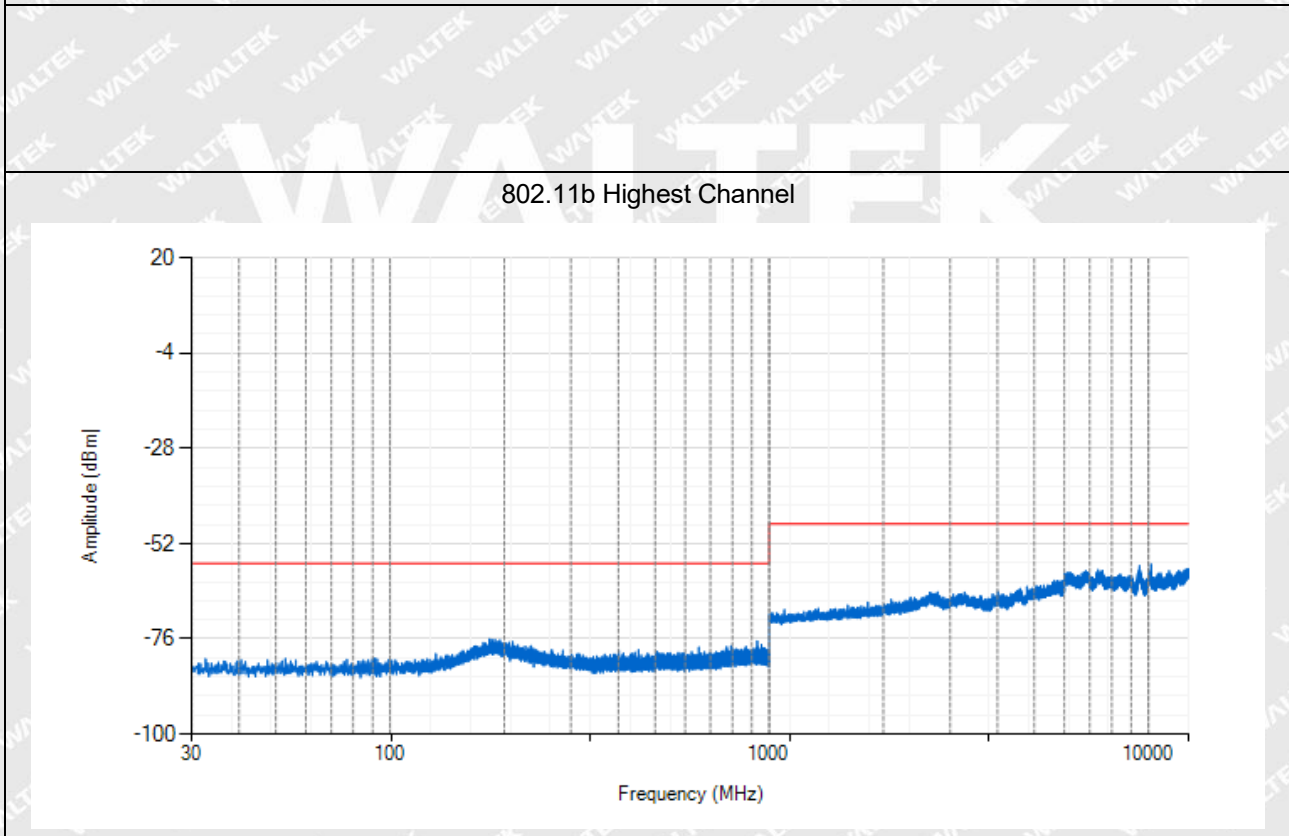
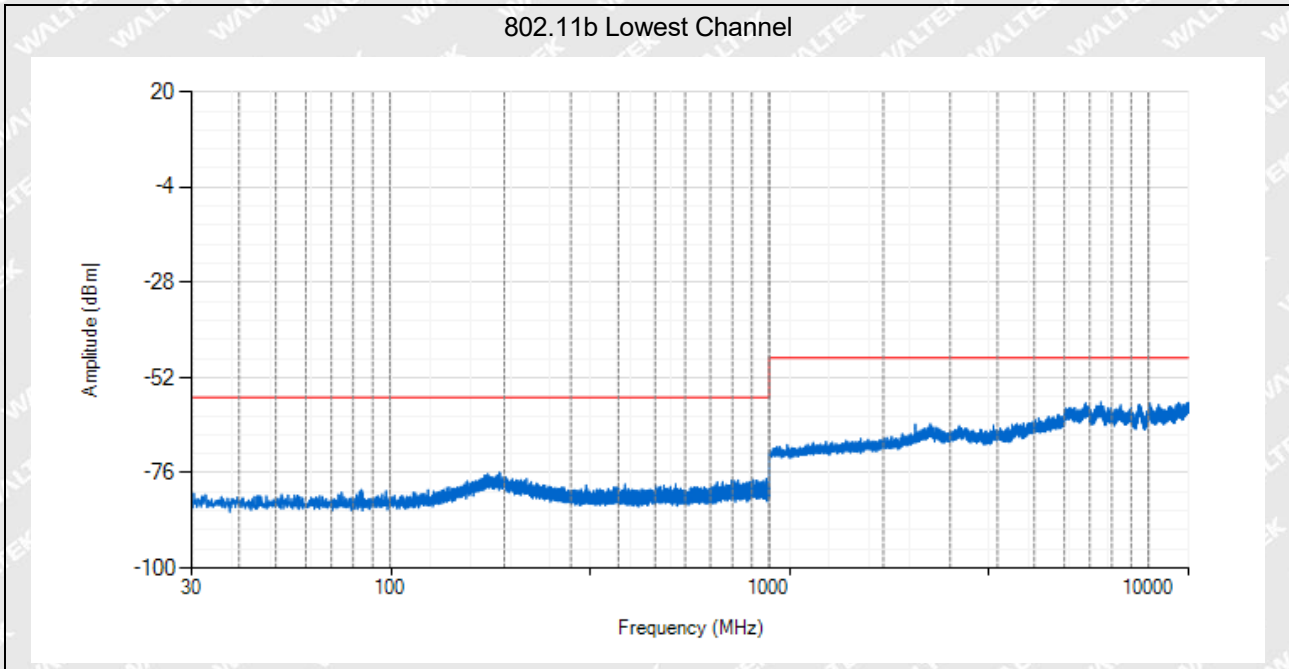

Note1: Testing is carried out with frequency rang 30MHz to 12.75GHz, which above 1GHz are attenuated more than 20dB below the permissible limits or the field strength is too small to be measured.

Note2: Pre-scan 802.11b, 802.11g, 802.11n(HT20) mode, and found the 802.11b mode which it is worse case, so only show the test data for worse case.



10. Receiver Blocking

10.1 Standard Application

According to section 4.3.2.11.2, receiver blocking is a measure of the ability of the equipment to receive a wanted signal on its operating channel without exceeding a given degradation in the presence of an unwanted signal (blocking signal) at frequencies other than those of the operating band.

Load Based Equipment not using any of the mechanisms referenced above shall comply with the following minimum set of requirements :

The minimum performance criterion shall be a PER less than or equal to 10 %. The manufacturer may declare alternative performance criteria as long as that is appropriate for the intended use of the equipment (see clause 5.4.1.t)).

While maintaining the minimum performance criteria as defined in clause 4.3.2.11.3, the blocking levels at specified frequency offsets shall be equal to or greater than the limits defined for the applicable receiver category 1, 2 and 3 provided in table 14, table 15 or table 16.

Receiver category 1

Adaptive equipment with a maximum RF output power greater than 10 dBm e.i.r.p. shall be considered as receiver category 1 equipment.

Receiver category 2

non-adaptive equipment with a Medium Utilization (MU) factor greater than 1 % and less than or equal to 10 % (irrespective of the maximum RF output power); or equipment (adaptive or non-adaptive) with a maximum RF output power greater than 0 dBm e.i.r.p. and less than or equal to 10 dBm e.i.r.p.

Receiver category 3

non-adaptive equipment with a maximum Medium Utilization (MU) factor of 1 % (irrespective of the maximum RF output power); or equipment (adaptive or non-adaptive) with a maximum RF output power of 0 dBm e.i.r.p.



Table 14: Receiver Blocking parameters for Receiver Category 1 equipment.

Wanted signal mean power from companion device (dBm) (see notes 1 and 4)	Blocking signal frequency (MHz)	Blocking signal power (dBm) (see note 4)	Type of blocking signal
(-133 dBm + 10 × log ₁₀ (OCBW)) or -68 dBm whichever is less (see note 2)	2380 2504	-34	CW
(-139dBm + 10 × log ₁₀ (OCBW)) or -74dBm whichever is less (see note 3)	2300 2330 2360 2524 2584 2674		

NOTE 1: OCBW is in Hz.

NOTE 2: In case of radiated measurements using a companion device and the level of the wanted signal from the companion device cannot be determined, a relative test may be performed using a wanted signal up to $P_{min} + 26$ dB where P_{min} is the minimum level of wanted signal required to meet the minimum performance criteria as defined in clause 4.3.1.12.3 in the absence of any blocking signal.

NOTE 3: In case of radiated measurements using a companion device and the level of the wanted signal from the companion device cannot be determined, a relative test may be performed using a wanted signal up to $P_{min} + 20$ dB where P_{min} is the minimum level of wanted signal required to meet the minimum performance criteria as defined in clause 4.3.1.12.3 in the absence of any blocking signal.

NOTE 4: The level specified is the level at the UUT receiver input assuming a 0 dBi antenna assembly gain. In case of conducted measurements, this level has to be corrected for the (in-band) antenna assembly gain (G). In case of radiated measurements, this level is equivalent to a power flux density (PFD) in front of the UUT antenna with the UUT being configured/positioned as recorded in clause 5.4.3.2.2.



Table 15: Receiver Blocking parameters receiver category 2 equipment.

Wanted signal mean power from companion device (dBm) (see notes 1 and 3)	Blocking signal frequency (MHz)	Blocking signal power (dBm) (see note 3)	Type of blocking signal
$(-139 \text{ dBm} + 10 \times \log_{10}(\text{OCBW}) + 10 \text{ dB})$ or $(-74 \text{ dBm} + 10 \text{ dB})$ whichever is less (see note 2)	2380 2504 2300 2584	-34	CW
NOTE 1: OCBW is in Hz.			
NOTE 2: In case of radiated measurements using a companion device and the level of the wanted signal from the companion device cannot be determined, a relative test may be performed using a wanted signal up to $P_{\min} + 26 \text{ dB}$ where P_{\min} is the minimum level of wanted signal required to meet the minimum performance criteria as defined in clause 4.3.1.12.3 in the absence of any blocking signal.			
NOTE 3: The level specified is the level at the UUT receiver input assuming a 0 dBi antenna assembly gain. In case of conducted measurements, this level has to be corrected for the (in-band) antenna assembly gain (G). In case of radiated measurements, this level is equivalent to a power flux density (PFD) in front of the UUT antenna with the UUT being configured/positioned as recorded in clause 5.4.3.2.2.			

Table 16: Receiver Blocking parameters receiver category 3 equipment

Wanted signal mean power from companion device (dBm) (see notes 1 and 3)	Blocking signal frequency (MHz)	Blocking signal power (dBm) (see note 3)	Type of blocking signal
$(-139 \text{ dBm} + 10 \times \log_{10}(\text{OCBW}) + 20 \text{ dB})$ or $(-74 \text{ dBm} + 20 \text{ dB})$ whichever is less (see note 2)	2380 2504 2300 2584	-34	CW
NOTE 1: OCBW is in Hz.			
NOTE 2: In case of radiated measurements using a companion device and the level of the wanted signal from the companion device cannot be determined, a relative test may be performed using a wanted signal up to $P_{\min} + 26 \text{ dB}$ where P_{\min} is the minimum level of wanted signal required to meet the minimum performance criteria as defined in clause 4.3.1.12.3 in the absence of any blocking signal.			
NOTE 3: The level specified is the level at the UUT receiver input assuming a 0 dBi antenna assembly gain. In case of conducted measurements, this level has to be corrected for the (in-band) antenna assembly gain (G). In case of radiated measurements, this level is equivalent to a power flux density (PFD) in front of the UUT antenna with the UUT being configured/positioned as recorded in clause 5.4.3.2.2.			



10.2 Test Procedure

Step 1: • For non-frequency hopping equipment, the UUT shall be set to the lowest operating channel.

Step 2: • The blocking signal generator is set to the first frequency as defined in the appropriate table corresponding to the receiver category and type of equipment.

Step 3: • With the blocking signal generator switched off, a communication link is established between the UUT and the associated companion device using the test setup shown in figure 6. The variable attenuator is set to a value that achieves the minimum performance criteria as specified in clause 4.3.1.12.3 or clause 4.3.2.11.3 with a resolution of at least 1 dB. The resulting level for the wanted signal at the input of the UUT is Pmin. This value shall be measured and recorded in the test report.

• The signal level is increased by the value provided in the table corresponding to the receiver category and type of equipment.

Step 4: • The blocking signal at the UUT is set to the level provided in the table corresponding to the receiver category and type of equipment. It shall be verified and recorded in the test report that the performance criteria as specified in clause 4.3.1.12.3 or clause 4.3.2.11.3 is met.

Step 5: • Repeat step 4 for each remaining combination of frequency and level for the blocking signal as provided in the table corresponding to the receiver category and type of equipment.

Step 6: • For non-frequency hopping equipment, repeat step 2 to step 5 with the UUT operating at the highest operating channel.

10.3 Test Setup

According to the section 5.4.11.2.1, the test block diagram shall be used.

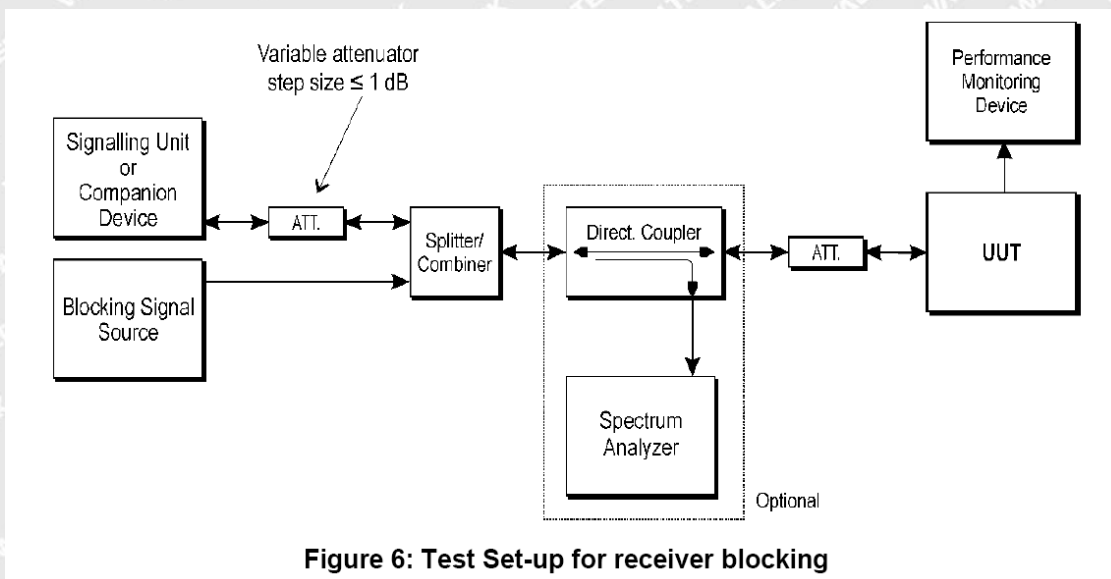

All test procedure is carried to the section 5.4.11.2.1



10.4 Summary of Test Results/Plots

The product is receiver category 1

Worst case at 802.11b mode						
Operating Channel	Wanted signal power (dBm)	Blocking signal Frequency (MHz)	Blocking signal power (dBm)	Test PER(%)	Limit(%)	Result
Lowest	-63.72	2380	-29.72	0	<10.00	Pass
		2504				
	-69.72	2300	-29.72	0	<10.00	Pass
		2330				
		2360				
		2524				
		2584				
2674						
Highest	-63.72	2380	-29.72	0	<10.00	Pass
		2504				
	-69.72	2300	-29.72	0	<10.00	Pass
		2330				
		2360				
		2524				
		2584				
2674						

*communication link is established between the UUT and the associated companion device using the test setup shown in figure 6. While the Companion device (CMW500) adjust to a level which can obtain the minimum performance criteria PER 10%, This level define to Pmin

Remark: the smallest channel bandwidth shall be used together with the lowest data rate for this channel bandwidth. This mode of operation are aligned with the performance criteria defined in clause 4.3.1.12.3 or clause 4.3.2.11.3 as declared by the manufacturer (see clause 5.4.1.t)).



EXHIBIT 1 - EUT PHOTOGRAPHS

Please refer to “ANNEX”.

WALTEK



EXHIBIT 2 - TEST SETUP PHOTOGRAPHS

**Spurious Emission
Test Setup
(Below 1GHz)**

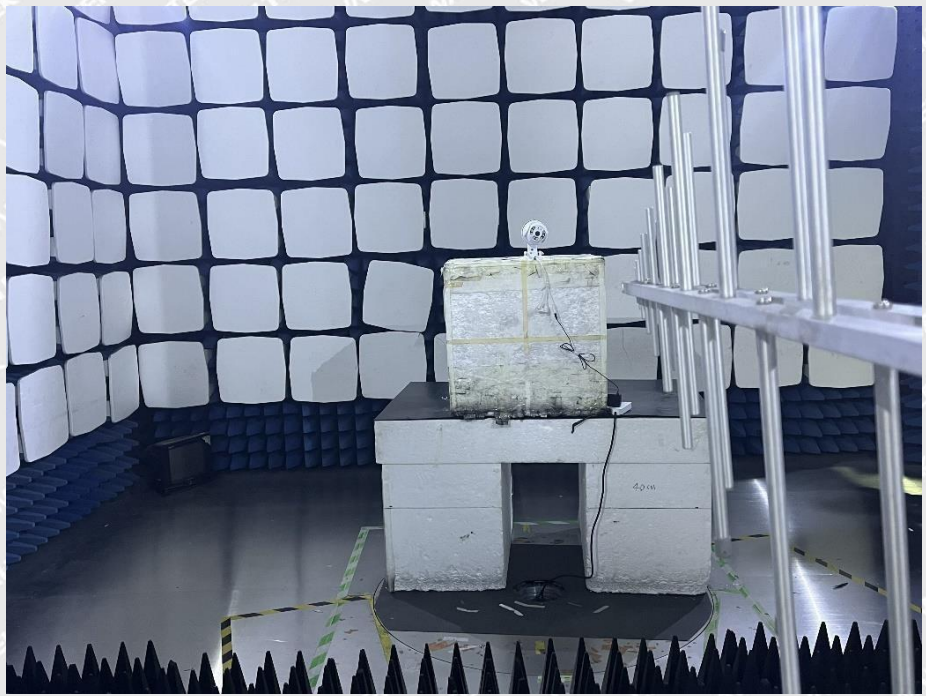

**Spurious Emission
Test Setup (Above
1GHz)**



***** END OF REPORT *****